



EXTERIOR LIGHTING MORA



www.moralighting.co.id

 Jl. H. Liyas No.34, Paninggilan, Kec. Ciledug,
Kota Tangerang, Banten 15153

PROJECTORS

FOR OUTDOOR APPLICATIONS



Rose Series Projector



ROSE Pro



ROSE



ROSE Mini

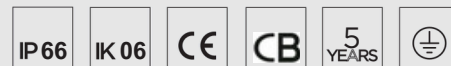

Technical data

Wattage	3/6/8W
IP Rating	IP66
IK Rating	IK06
Material	High corrosion resistance die-cast copper-free aluminum body
Coating	Polyester powder coating with phosphochromating pre-finish
Light source	1 x COB CRI>90
Standard Deviation Color Matching	:MacAdam step 3
Screws	Stainless steel
Transformer	Electronic power supply AC120-277V or DC12-24V
Gasket	Silicone rubber
Glass	Tempered
Power cable	0.5 mt. neoprene power cable included
Gross weight	0.35 Kg
Packaging size	41*21*41cm(20Pcs) 8.6kg

ROSE Mini

MR-SL 1.0

Whether lighting up a tree from below or hanging a

fixture from it, to using a ground spike, pole clamp or yoke arm, there is a mounting solution to suit every application.

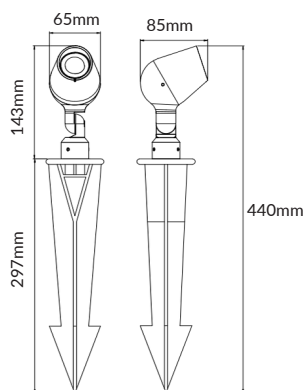

Option

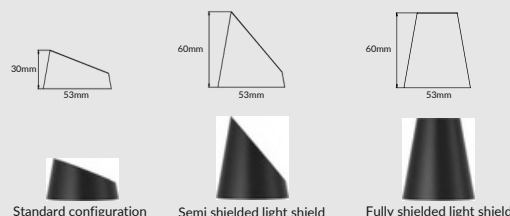

*Different types of light shields can be replaced on site

OPTICAL ACCESSORIES

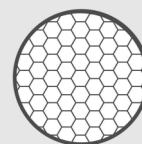

Honeycomb louvre built into the lighting fixture

light source*	lumen output (lm)	lumin. efficacy (lm/w)	light beam options
3000°K warm-white			
3W COB	240.0	80.0	15°
6W COB	480.0		24°
8W COB	640.0		36°
			40°-70°

2700/4000/5000K CCT available on request

Finish color options :

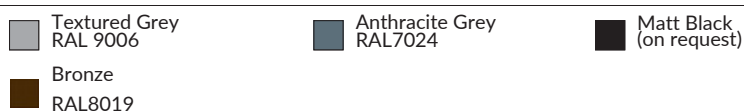

Customizable in different finishing colors



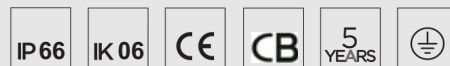

Technical data

Wattage	10/15/20W
IP Rating	IP66
IK Rating	IK06
Material	High corrosion resistance die-cast copper-free aluminum body
Coating	Polyester powder coating with phosphochromating pre-finish
Light source	1 x COB CRI>90
Standard Deviation Color Matching	:MacAdam step 3
Screws	Stainless steel
Transformer	Electronic power supply 220/240V 50/60Hz built-in or(AC120-277V)/(DC12-24V)
Gasket	Silicone rubber
Glass	Tempered
Power cable	0.5 mt. neoprene power cable included
Gross weight	1.1 Kg
Packaging size	3 3*27*31cm(6Pcs) 6.5kg

ROSE

MR-SL 2.0

Whether lighting up a tree from below or hanging a fixture from it, to using a ground spike, pole clamp or yoke arm, there is a mounting solution to suit every application.

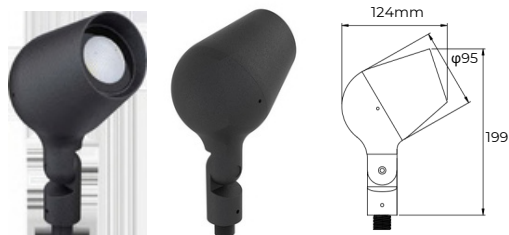
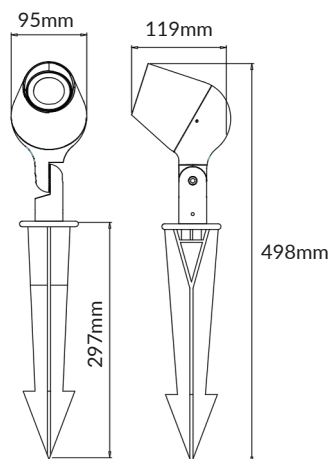

light source*	lumen output (lm)	lumin. efficacy (lm/w)	light beam options
3000°K warm-white			
10W COB	960.0	96.00	15°
15W COB	1440.0		24°
20W COB	1920.0		36°
			40°-70°

2700/4000/5000K CCT available on request

Finish color options :

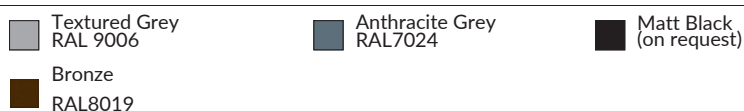

Customizable in different finishing colors

OPTICAL ACCESSORIES

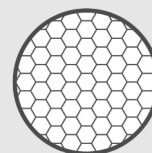

Honeycomb louvre built into the lighting fixture

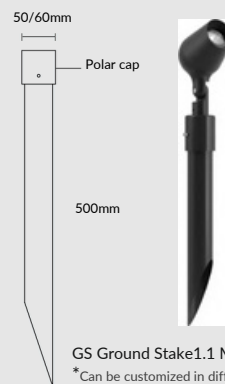

GS Ground Stake 1.1 Material: PVC
*Can be customized in different lengths



NEW



ROSE

MR-SL 2.0+

Whether lighting up a tree from below or hanging a fixture from it, to using a ground spike, pole clamp or yoke arm, there is a mounting solution to suit every application.

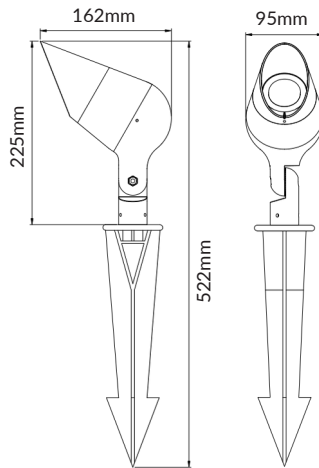

light source*	lumen output (lm)	lumin. efficacy (lm/w)	light beam options
3000°K warm-white			
10W COB	960.0	96.00	15°
15W COB	1440.0		24°
20W COB	1920.0		36°
			40°*70°

2700/4000/5000K CCT available on request

Finish color options :

- Textured Grey RAL 9006
- Anthracite Grey RAL7024
- Matt Black (on request)
- Bronze RAL8019

Customizable in different finishing colors

Mora

Professional Lighting

Technical features



Technical data

Wattage	10/15/20W
IP Rating	IP66
IK Rating	IK06
Material	High corrosion resistance die-cast copper-free aluminum body
Coating	Polyester powder coating with phosphochromating pre-finish
Light source	1 x COB CRI>90
Standard Deviation Color Matching :MacAdam step 3	
Screws	Stainless steel
Transformer	Electronic power supply 220/240V 50/60Hz built-in or(AC120-277V)/(DC12-24V)
Gasket	Silicone rubber
Glass	Tempered
Power cable	0.5 mt. neoprene power cable included
Gross weight	1.1 Kg
Packaging size	33*27*31cm(6Pcs) 6.5kg

OPTICAL ACCESSORIES

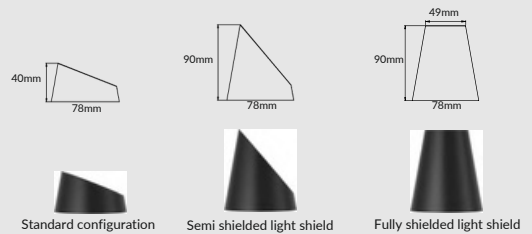

*Different types of light shields can be replaced on site

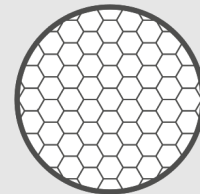

Honeycomb louvre built into the lighting fixture



Technical features

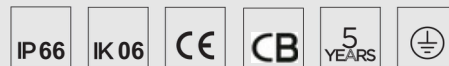

Technical data

Wattage	30/40/60W
IP Rating	IP66
IK Rating	IK06
Material	High corrosion resistance die-cast copper-free aluminum body
Coating	Polyester powder coating with phosphochromating pre-finish
Light source	1 x COB CRI>90
Standard Deviation Color Matching	:MacAdam step 3
Screws	Stainless steel
Transformer	Electronic power supply 220/240V 50/60Hz built-in or AC120-277V
Gasket	Silicone rubber
Glass	Tempered
Power cable	0.5 mt. neoprene power cable included
Gross weight	2.15 Kg
Packaging size	32*32*42cm 4PCS 8.6kg

ROSE Pro

MR-SL 3.0

Whether lighting up a tree from below or hanging a fixture from it, to using a ground spike, pole clamp or yoke arm, there is a mounting solution to suit every application.

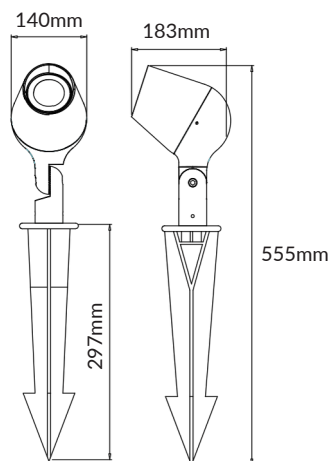

OPTICAL ACCESSORIES

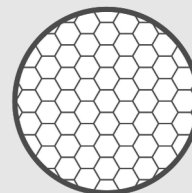

Honeycomb louvre built into the lighting fixture

light source*	lumen output (lm)	lumin. efficacy (lm/w)	light beam options
3000°K warm-white			
30W COB	3000.0	100.00	15°
40W COB	4000.0		24°
60W COB	6000.0		36°
			40°-70°

2700/4000/5000K CCT available on request

Finish color options :

- Textured Grey RAL 9006
- Anthracite Grey RAL7024
- Matt Black (on request)
- Bronze RAL8019

Customizable in different finishing colors

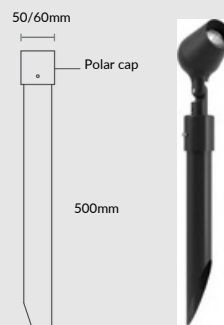

GS Ground Stake 1.1 Material: PVC
*Can be customized in different lengths



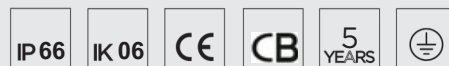

Technical data

Wattage	3/6/8W
IP Rating	IP66
IK Rating	IK06
Material	High corrosion resistance die-cast copper-free aluminum body
Coating	Polyester powder coating with phosphochromating pre-finish
Light source	1 x COB CRI>90
Standard Deviation Color Matching :MacAdam step 3	
Screws	Stainless steel
Transformer	Electronic power supply AC120-277V or DC12-24V
Gasket	Silicone rubber
Glass	Tempered
Power cable	0.5 mt. neoprene power cable included
Gross weight	0.35 Kg
Packaging size	41*21*41cm(20Pcs) 8.6kg

ROSE Mini

MR-SL 1.1

Whether lighting up a tree from below or hanging a

fixture from it, to using a ground spike, pole clamp or yoke arm, there is a mounting solution to suit every application.



light source*	lumen output (lm)	lumin. efficacy (lm/w)	light beam options
3000°K warm-white 3W COB	240.0	80.0	15°
6W COB	480.0		24°
8W COB	640.0		60°
			40°-70°

2700/4000/5000K CCT available on request

Finish color options :

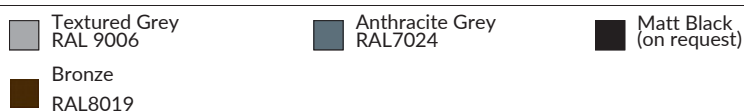

Customizable in different finishing colors

Option

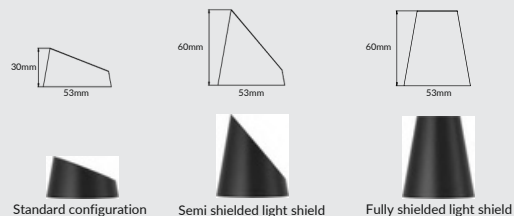

*Different types of light shields can be replaced on site

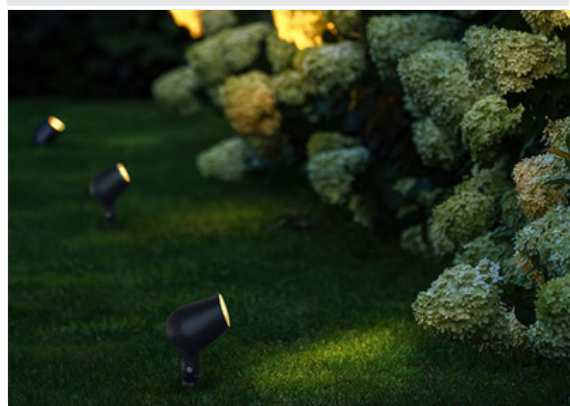

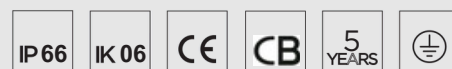

Technical data

Wattage	IP	10/15/20W
Rating	IK	IP66
Rating Material	IK06	
Coating	High corrosion resistance die-cast copper-free aluminum body	
Light source	Polyester powder coating with phosphochromating pre-finish	
Standard Deviation Color Matching	1 x COB CRI>90	
Screws	Stainless steel	
Transformer	Electronic power supply 220/240V 50/60Hz built-in or(AC120-277V)/(DC12-24V)	
Gasket	Silicone rubber	
Glass	Tempered	
Power cable	0.5 mt. neoprene power cable included	
Gross weight	1.2 Kg	
Packaging size	33*27*31cm(6Pcs) 6.5kg	

ROSE

MR-SL 2.1

Whether lighting up a tree from below or hanging a fixture from it, to using a ground spike, pole clamp or yoke arm, there is a mounting solution to suit every application.

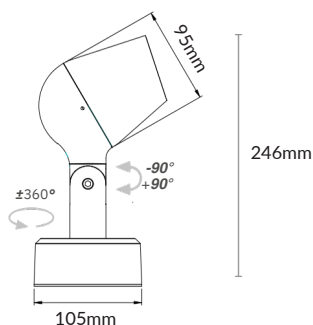

light source*	lumen output (lm)	lumin. efficacy (lm/w)	light beam options
3000°K warm-white 10W COB	960.0	96.00	15°
15W COB			24°
20W COB	36°		
	40°-70°		

2700/4000/5000K CCT available on request

Finish color options :

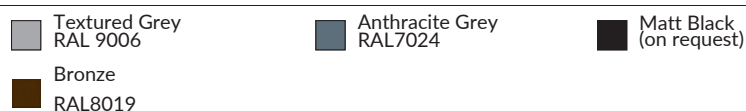

Customizable in different finishing colors

OPTICAL ACCESSORIES

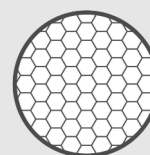

Honeycomb louvre built into the lighting fixture

OPTION

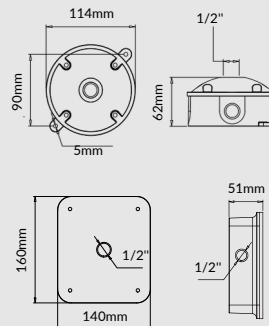

NEW



ROSE

MR-SL 2.1+

Whether lighting up a tree from below or hanging a fixture from it, to using a ground spike, pole clamp or yoke arm, there is a mounting solution to suit every application.

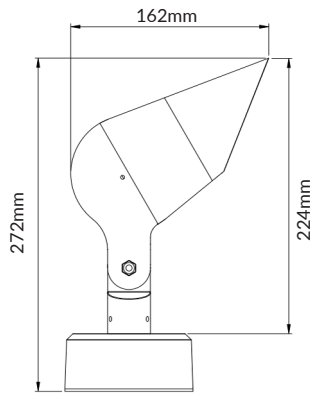

light source*	lumen output (lm)	lumin. efficacy (lm/w)	light beam options
3000°K warm-white			
10W COB	960.0	96.00	15°
15W COB	1440.0		24°
20W COB	1920.0		36°
			40°-70°

2700/4000/5000K CCT available on request

Finish color options :

- Textured Grey
RAL 9006
- Anthracite Grey
RAL7024
- Matt Black
(on request)
- Bronze
RAL8019

Customizable in different finishing colors

Mora

Professional Lighting

Technical features



Technical data

Wattage	10/15/20W
IP Rating	IP66
IK Rating	IK06
Material	High corrosion resistance die-cast copper-free aluminum body
Coating	Polyester powder coating with phosphochromating pre-finish
Light source	1 x COB CRI>90
Standard Deviation Color Matching	:MacAdam step 3
Screws	Stainless steel
Transformer	Electronic power supply 220/240V 50/60Hz built-in or(AC120-277V)/(DC12-24V)
Gasket	Silicone rubber
Glass	Tempered
Power cable	0.5 mt. neoprene power cable included
Gross weight	1.2 Kg
Packaging size	33*27*31cm(6Pcs) 6.5kg

OPTION

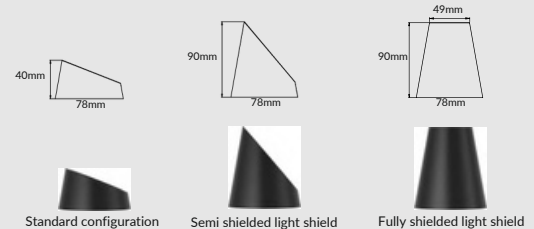

*Different types of light shields can be replaced on site

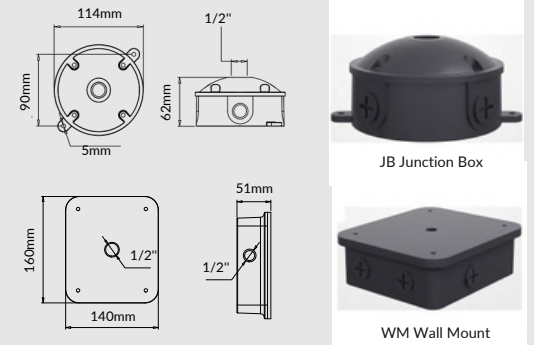

Technical features

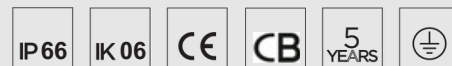

Technical data

Wattage	30/40/60W
IP Rating	IP66
IK Rating	IK06
Material	High corrosion resistance die-cast copper-free aluminum body
Coating	Polyester powder coating with phosphochromating pre-finish
Light source	1 x COB CRI>90
Standard Deviation Color Matching :MacAdam step 3	
Screws	Stainless steel
Transformer	Electronic power supply 220/240V 50/60Hz built-in or AC120-277V
Gasket	Silicone rubber
Glass	Tempered
POWER CABLES	Neoprene cable 3x0.75
Power cable	0.5 mt. neoprene power cable included
Gross weight	2.15 Kg
Packaging size	32*32*42cm 4PCS 8.6kg



ROSE Pro

MR-SL 3.1

Whether lighting up a tree from below or hanging a fixture from it, to using a ground spike, pole clamp or yoke arm, there is a mounting solution to suit every application.

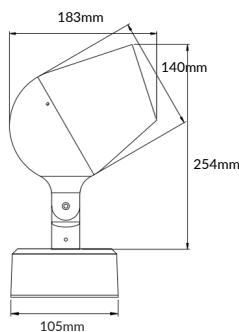

light source*	lumen output (lm)	lumin. efficacy (lm/w)	light beam options
3000°K warm-white			
30W COB	3000.0	100.00	15°
40W COB	4000.0		24°
60W COB	6000.0		36°
			40°-70°

2700/4000/5000K CCT available on request

Finish color options :

- Textured Grey
RAL 9006
- Anthracite Grey
RAL7024
- Matt Black
(on request)
- Bronze
RAL8019

Customizable in different finishing colors

OPTICAL ACCESSORIES

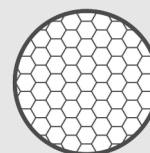

Honeycomb louvre built into the lighting fixture

OPTION

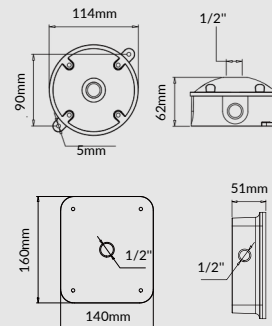

JB Junction Box



WM Wall Mount





Mora®

Professional Lighting

Technical features



Technical data

Wattage	12W
IP Rating	IP66
IK Rating	IK06
Material	High corrosion resistance die-cast copper-free aluminum body
Coating	Polyester powder coating with phosphochromating pre-finish
Light source	1 x COB CRI>80
Standard Deviation Color Matching	:MacAdam step 3
Screws	Stainless steel
Transformer	Silicone rubber
Gasket	Electronic power supply DC 24V
Wireless transmission distance	: 30m
Power cable	0.5 mt. neoprene power cable included
Gross weight	1.2 Kg
Packaging size	33*27*31cm(6Pcs) 6.5kg

ROSE RGBW

MR-SL 2.0-RGBW

Whether lighting up a tree from below or hanging a fixture from it, to using a ground spike, pole clamp or yoke arm, there is a mounting solution to suit every application.

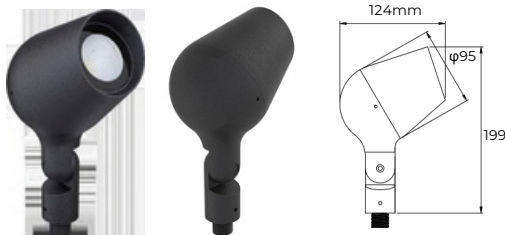

light source*	lumen output (lm)	lumin. efficacy (lm/w)	light beam options
RGBW			
12W COB	396.0	33.00	

OPTION

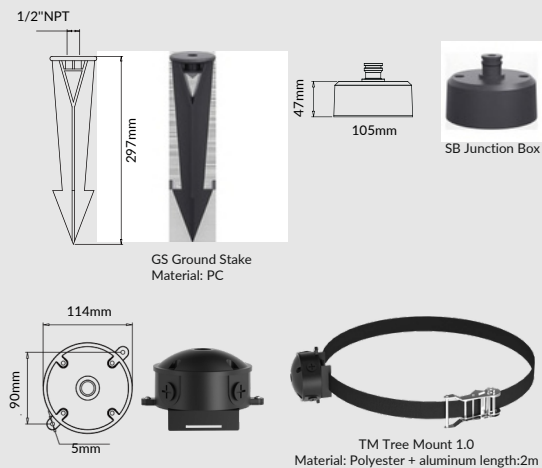

Finish color options :

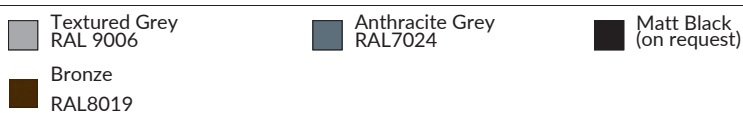

Customizable in different finishing colors



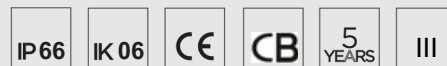

DMX512

Technical data

Wattage	12W
IP Rating	IP66
IK Rating	IK06
Material	High corrosion resistance die-cast copper-free aluminum body
Coating	Polyester powder coating with phosphochromating pre-finish
Light source	3x 3535LED CRI>80
Standard Deviation Color Matching	:MacAdam step 3
Screws	Stainless steel
Transformer	Silicone rubber
Gasket	Electronic power supply DC 24V
Power cable	0.5 mt. neoprene power cable included
Gross weight	1.2 Kg
Packaging size	33*27*31cm(6Pcs) 6.5kg



ROSE RGBW

MR-SL2.0-RGBW-512

Whether lighting up a tree from below or hanging a fixture from it, to using a ground spike, pole clamp or yoke arm, there is a mounting solution to suit every application.

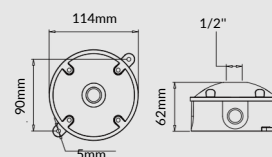
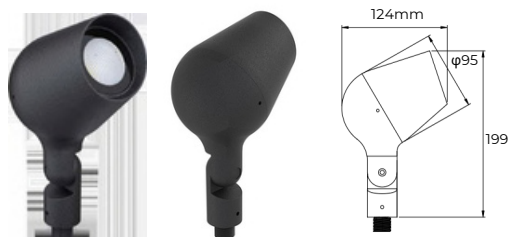

light source*	lumen output (lm)	lumin. efficacy (lm/w)	light beam options										
RGBW													
12W	396.0	33.00	<table border="0"> <tr><td></td><td>15°</td></tr> <tr><td></td><td>24°</td></tr> <tr><td></td><td>36°</td></tr> <tr><td></td><td>60°</td></tr> <tr><td></td><td>40°70°</td></tr> </table>		15°		24°		36°		60°		40°70°
	15°												
	24°												
	36°												
	60°												
	40°70°												

Finish color options :

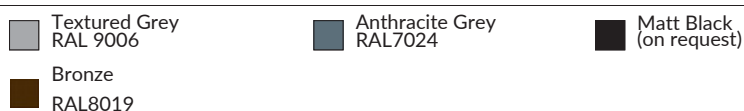

Customizable in different finishing colors



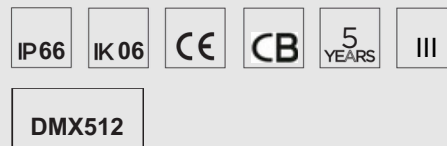

ROSE Pro RGBW

MR-SL 3.0-RGBW-512

Whether lighting up a tree from below or hanging a fixture from it, to using a ground spike, pole clamp or yoke arm, there is a mounting solution to suit every application.

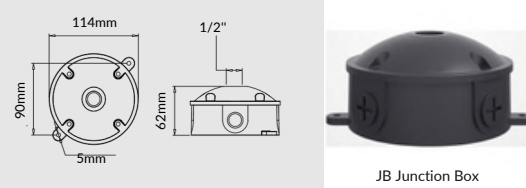

light source*	lumen output (lm)	lumin. efficacy (lm/w)	light beam options
RGBW			
24W	792.0	33.00	15°
			24°
36W	1188.0		36°
			60°
			40°*70°

Finish color options :

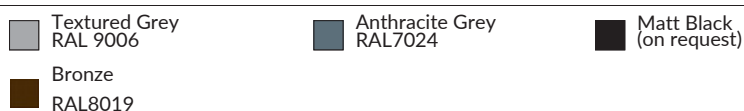

Customizable in different finishing colors

Technical data

Wattage IP	24/36W
Rating IK	IP66
Rating Material	IK06
	High corrosion resistance die-cast copper-free aluminum body
Coating	Polyester powder coating with phosphochromating pre-finish
Light source	8x 3535LED CRI>80
Standard Deviation Color Matching	:MacAdam step 3
Screws	Stainless steel
Transformer	Silicone rubber
Gasket	Electronic power supply DC 24V
Power Cables	Neoprene cable 5x0.75
Power cable	0.5 mt. neoprene power cable included
Gross weight	2.15 Kg
Packaging size	32*32*42cm 4PCS 8.2Kg



Technical features

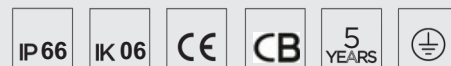

Technical data

Wattage	3/6/8W
IP Rating	IP66
IK Rating	IK06
Material	High corrosion resistance die-cast copper-free aluminum body
Coating	Polyester powder coating with phosphochromating pre-finish
Light source	1 x COB CRI>90
Standard Deviation Color Matching	MacAdam step 3
Screws	Stainless steel
Transformer	Electronic power supply AC120-277V or DC12-24V
Gasket	Silicone rubber
Glass	Tempered
Power cable	0.5 mt. neoprene power cable included

ROSE Mini

MR-SL 1.2

Whether lighting up a tree from below or hanging a

fixture from it, to using a ground spike, pole clamp or yoke arm, there is a mounting solution to suit every application.

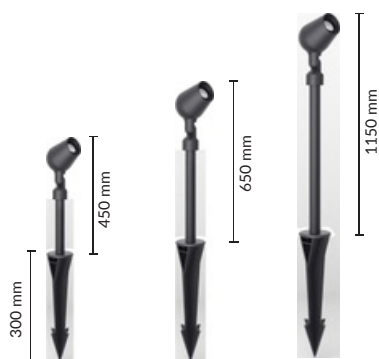

φ25mm **Extension arm 300 mm**
Extension pipe length 300 mm made in anodized aluminum.

φ25mm **Extension arm 500 mm**
Extension pipe length 600 mm made in anodized aluminum.

φ25mm **Extension arm 1000 mm**
Extension pipe length 1000 mm made in anodized aluminum.

light source*	lumen output (lm)	lumin. efficacy (lm/w)	light beam options
3000°K warm-white			
3W COB	240.0	80.0	15°
6W COB	480.0		24°
8W COB	640.0		36°
			40°*70°

2700/4000/5000K CCT available on request

Finish color options :

- Textured Grey RAL 9006
- Anthracite Grey RAL7024
- Matt Black (on request)
- Bronze RAL8019

Customizable in different finishing colors

Option

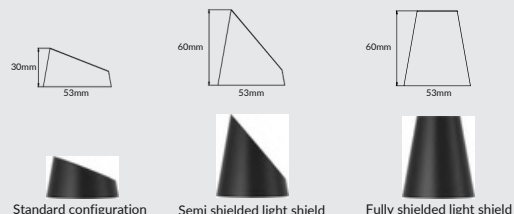

*Different types of light shields can be replaced on site

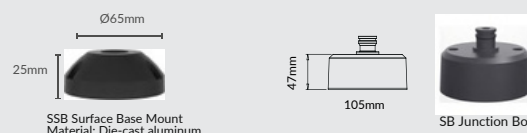

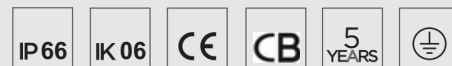

Technical data

Wattage	10/15/20W
IP Rating	IP66
IK Rating	IK06
Material	High corrosion resistance die-cast copper-free aluminum body
Coating	Polyester powder coating with phosphochromating pre-finish
Light source	1 x COB CRI>90
Standard Deviation Color Matching	:MacAdam step 3
Screws	Stainless steel
Transformer	Electronic power supply 220/240V 50/60Hz built-in or(AC120-277V)/(DC12-24V)
Gasket	Silicone rubber
Glass	Tempered
Power Cables	Neoprene cable 3x0.75
Power cable	0.5 mt. neoprene power cable included
Gross weight	1.2 Kg
Packaging size	33*27*31cm(6Pcs) 6.5kg



ROSE

MR-SL 2.2

Whether lighting up a tree from below or hanging a fixture from it, to using a ground spike, pole clamp or yoke arm, there is a mounting solution to suit every application.

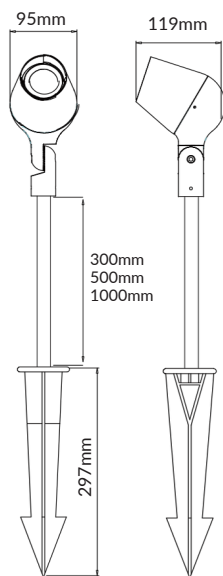

φ25mm Extension arm 300 mm
Extension pipe length 300 mm made in anodized aluminum.

φ25mm Extension arm 500 mm
Extension pipe length 600 mm made in anodized aluminum.

φ25mm Extension arm 1000 mm
Extension pipe length 900 mm made in anodized aluminum.

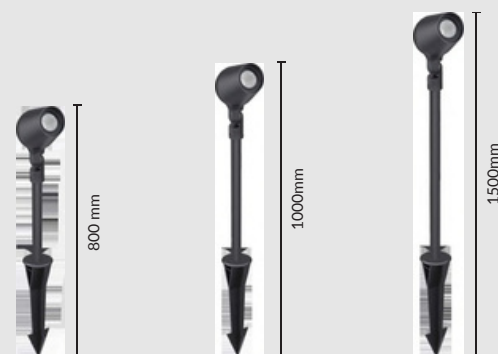

light source*	lumen output (lm)	lumin. efficacy (lm/w)	light beam options
3000°K warm-white			
10W COB	960.0	96.00	15°
15W COB	1440.0		24°
20W COB	1920.0		36°
			40°-70°

2700/4000/5000K CCT available on request

Finish color options :

- Textured Grey RAL 9006
- Anthracite Grey RAL7024
- Matt Black (on request)
- Bronze
- RAL8019

Customizable in different finishing colors

OPTION

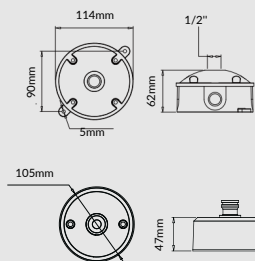

Technical features



Technical data

Wattage	30/40/60W
IP Rating	IP66
IK Rating	IK06
Material	High corrosion resistance die-cast copper-free aluminum body
Coating	Polyester powder coating with phosphochromating pre-finish
Light source	1 x COB CRI>90
Standard Deviation Color Matching	:MacAdam step 3
Screws	Stainless steel
Transformer	Electronic power supply 220/240V 50/60Hz built-in or AC120-277V
Gasket	Silicone rubber
Glass	Tempered
Power cable	0.5 mt. neoprene power cable included
Gross weight	2.15 Kg
Packaging size	32*32*42cm 4PCS 8.6kg

ROSE Pro

MR-SL 3.2

Whether lighting up a tree from below or hanging a fixture from it, to using a ground spike, pole clamp or yoke arm, there is a mounting solution to suit every application.

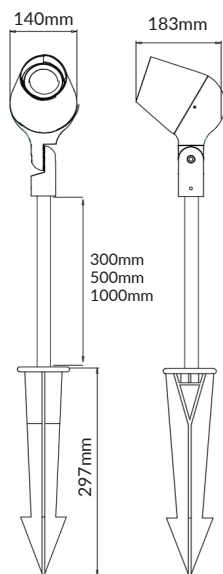

light source*	lumen output (lm)	lumin. efficacy (lm/w)	light beam options
3000°K warm-white			
30W COB	3000.0	100.00	15°
40W COB	4000.0		24°
60W COB	6000.0		36°
			40°-70°

2700/4000/5000K CCT available on request

Finish color options :

- Textured Grey RAL 9006
- Anthracite Grey RAL7024
- Matt Black (on request)
- Bronze RAL8019

Customizable in different finishing colors

φ25mm Extension arm 300 mm
Extension pipe length 300 mm made in anodized aluminum.

φ25mm Extension arm 500 mm
Extension pipe length 600 mm made in anodized aluminum.

φ25mm Extension arm 1000 mm
Extension pipe length 1000 mm made in anodized aluminum.

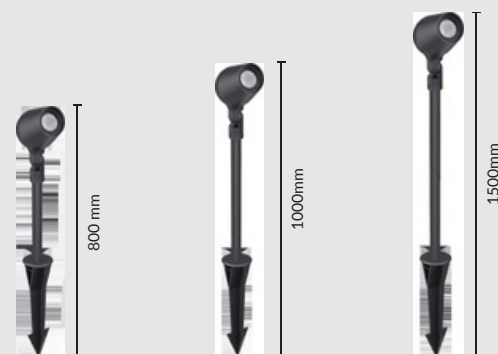

OPTION

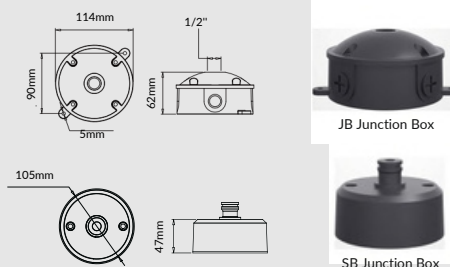

Technical features

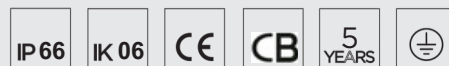

Technical data

Wattage	3/6/8W
IP Rating	IP66
IK Rating	IK06
Material	High corrosion resistance die-cast copper-free aluminum body
Coating	Polyester powder coating with phosphochromating pre-finish
Light source	1 x COB CRI>90
Standard Deviation Color Matching	:MacAdam step 3
Screws	Stainless steel
Transformer	Electronic power supply AC120-277V or DC12-24V
Gasket	Silicone rubber
Glass	Tempered
Power cable	0.5 mt. neoprene power cable included
Gross weight	0.35 Kg
Packaging size	41*21*41cm(20pcs) 8.6kg



ROSE Mini

MR-SL 1.3

Whether lighting up a tree from below or hanging a

fixture from it, to using a ground spike, pole clamp or yoke arm, there is a mounting solution to suit every application.



light source*	lumen output (lm)	lumin. efficacy (lm/w)	light beam options
3000°K warm-white			
3W COB	240.0	80.0	15°
6W COB	480.0		24°
8W COB	640.0		36°
			40°-70°

2700/4000/5000K CCT available on request

Option

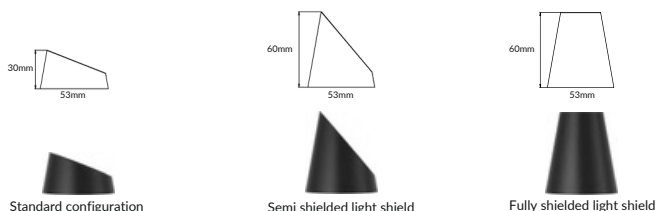

OPTION

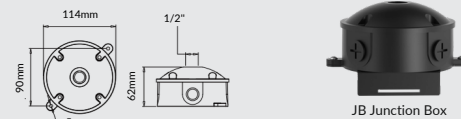

JB Junction Box

TM Tree Mount 1.0
Material: Polyester + aluminum length:2m

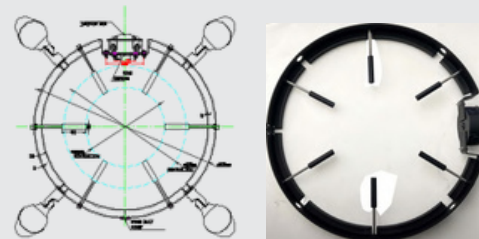

TM Tree Mount 2.0
Material: 304 stainless steel ring + die-casting aluminum waterproof box



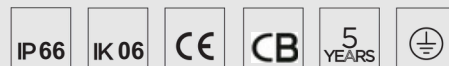

Technical data

Wattage	10/15/20W
IP Rating	IP66
IK Rating	IK06
Material	High corrosion resistance die-cast copper-free aluminum body
Coating	Polyester powder coating with phosphochromating pre-finish
Light source	1 x COB CRI>90
Standard Deviation Color Matching	:MacAdam step 3
Screws	Stainless steel
Transformer	Electronic power supply 220/240V 50/60Hz built-in or(AC120-277V)/(DC12-24V)
Gasket	Silicone rubber
Glass	Tempered
Power cable	0.5 mt. neoprene power cable included
Gross weight	1.2 Kg
Packaging size	33*27*31cm(6Pcs) 6.5kg



Tree Ring Installation

ROSE

MR-SL 2.3

Whether lighting up a tree from below or hanging a fixture from it, to using a ground spike, pole clamp or yoke arm, there is a mounting solution to suit every application.



light source*	lumen output (lm)	lumin. efficacy (lm/w)	light beam options
3000°K warm-white 10W COB	960.0	96.00	15°
15W COB	1440.0		24°
20W COB	1920.0		36°
			40°*70°

2700/4000/5000K CCT available on request

Finish color options :

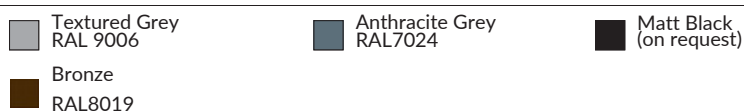

Customizable in different finishing colors

*Different tree ring sizes can be customized according to needs

OPTION

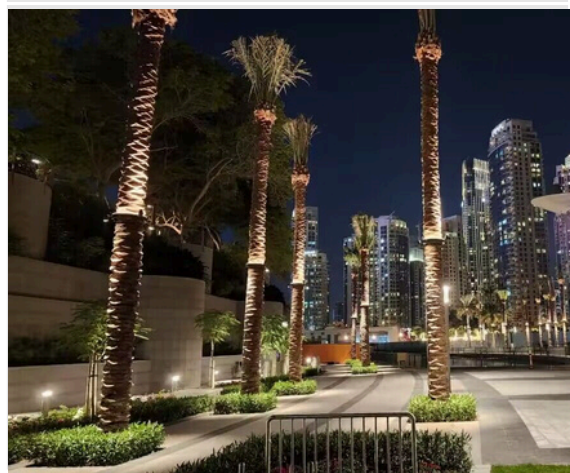
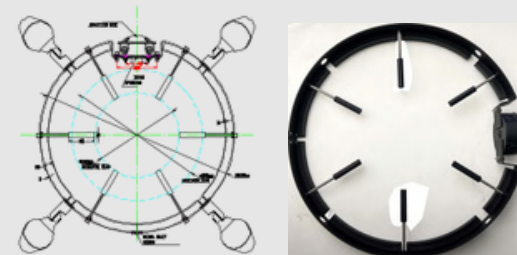
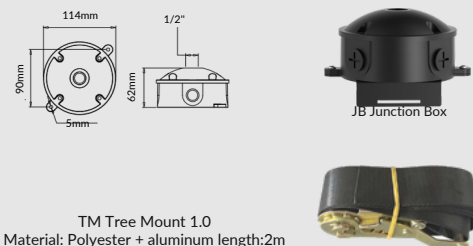

Technical features



Technical data

Wattage	30/40/60W
IP Rating	IP66
IK Rating	IK06
Material	High corrosion resistance die-cast copper-free aluminum body
Coating	Polyester powder coating with phosphochromating pre-finish
Light source	1 x COB CRI>90
Standard Deviation Color Matching	:MacAdam step 3
Screws	Stainless steel
Transformer	Electronic power supply 220/240V 50/60Hz built-in or AC120-277V
Gasket	Silicone rubber
Glass	Tempered
Power cable	0.5 mt. neoprene power cable included
Gross weight	2.15 Kg
Packaging size	32*32*42cm 4PCS 8.6kg



Tree Ring Installation

ROSE Pro

MR-SL 3.3

Whether lighting up a tree from below or hanging a fixture from it, to using a ground spike, pole clamp or yoke arm, there is a mounting solution to suit every application.



light source*	lumen output (lm)	lumin. efficacy (lm/w)	light beam options
3000°K warm-white 30W COB	3000.0	100.00	15°
40W COB	4000.0		24°
60W COB	6000.0		36°
			40°-70°

2700/4000/5000K CCT available on request

Finish color options :

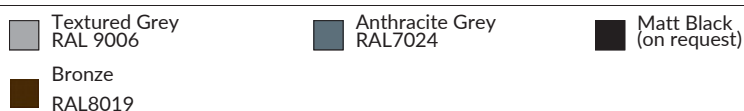

Customizable in different finishing colors

*Different tree ring sizes can be customized according to needs

OPTION

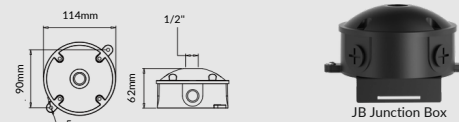

JB Junction Box

TM Tree Mount 1.0
Material: Polyester + aluminum length:2m

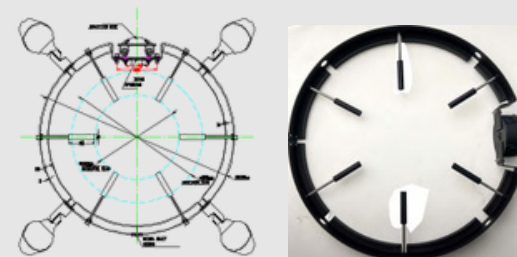

TM Tree Mount 2.0
Material: 304 stainless steel ring + die-casting aluminum waterproof box

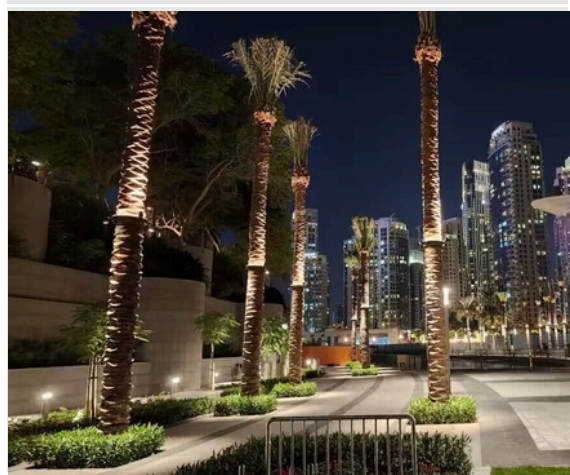



Technical data

Wattage	10/15/20W
IP Rating	IP66
IK Rating	IK06
Material	High corrosion resistance die-cast copper-free aluminum body
Coating	Polyester powder coating with phosphochromating pre-finish
Light source	1 x COB CRI>90
Standard Deviation Color Matching	:MacAdam step 3
Screws	Stainless steel
Transformer	Electronic power supply 220/240V 50/60Hz built-in or(AC120-277V)/(DC12-24V)
Gasket	Silicone rubber
Glass	Tempered
Power cable	0.5 mt. neoprene power cable included
Gross weight	1.2 Kg
Packaging size	33*27*31cm(6Pcs) 6.5kg



ROSE

MR-SL 2.4

Luminaire Suitable For Pole Mounting In Single Or Multiple Combinations

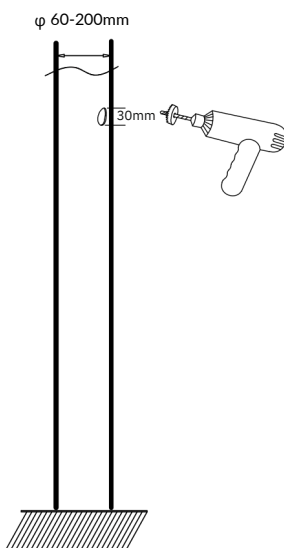

light source*	lumen output (lm)	lumin. efficacy (lm/w)	light beam options
3000°K warm-white 10W COB	960.0	96.00	15°
15W COB	1440.0		24°
20W COB	1920.0		36°
			60°
			40*70°

2700/4000/5000K CCT available on request

Finish color options :

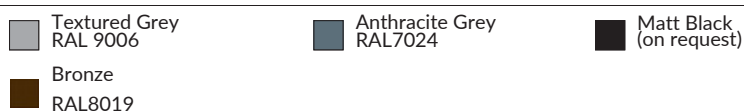

Customizable in different finishing colors

*Can be drilled on-site, φ30mm, flexible combination.



Coupler

Suitable to be used with poles diam. min 60 mm and diam. max 200 mm. Can be positioned on various staggered levels or on a single level, with the same pole. Made in phospho chromatised and polyester powder coated dia-cast copper-free aluminum material.

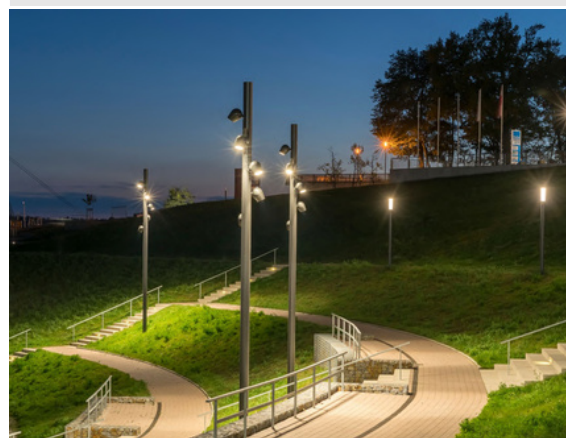



Mora

Professional Lighting

Technical features



Technical data

Wattage	30/40/60W
IP Rating	IP66
IK Rating	IK06
Material	High corrosion resistance die-cast copper-free aluminum body
Coating	Polyester powder coating with phosphochromating pre-finish
Light source	1 x COB CRI>90
Screws	Stainless steel
Transformer	Electronic power supply 220/240V 50/60Hz built-in or AC120-277V
Gasket	Silicone rubber
Glass	Tempered
Power cable	0.5 mt. neoprene power cable included
Gross weight	2.15 Kg
Packaging size	32*32*42cm 4PCS 8.6kg

ROSE Pro

MR-SL 3.4

Luminaire Suitable For Pole Mounting In Single Or Multiple Combinations

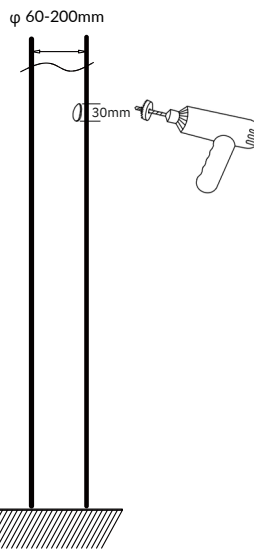

light source*	lumen output (lm)	lumin. efficacy (lm/w)	light beam options
3000°K warm-white 30W COB	3000.0	100.00	15°
40W COB	4000.0		24°
60W COB	6000.0		36°
			40°-70°

2700/4000/5000K CCT available on request

Finish color options :

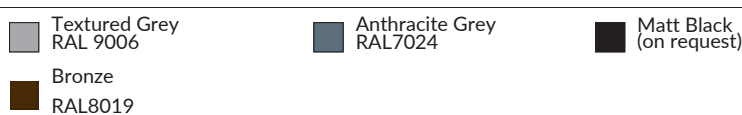

Customizable in different finishing colors

*Can be drilled on-site, φ30mm, flexible combination.



Coupler

Suitable to be used with poles diam. min 60 mm and diam. max 200 mm. Can be positioned on various staggered levels or on a single level, with the same pole. Made in phospho chromatised and polyester powder coated dia-cast copper-free aluminum material.

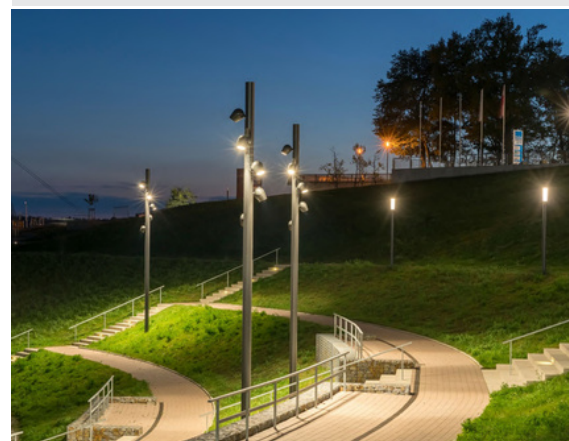



Mora

Professional Lighting

Technical features



Technical data

Wattage	10/15/20W
IP Rating	IP66
IK Rating	IK06
Material	High corrosion resistance die-cast copper-free aluminum body
Coating	Polyester powder coating with phosphochromating pre-finish
Light source	1 x COB CRI>90
Screws	Stainless steel
Transformer	Electronic power supply 220/240V 50/60Hz built-in or(AC120-277V)/(DC12-24V)
Gasket	Silicone rubber
Glass	Tempered
Power cable	0.5 mt. neoprene power cable included
Gross weight	1.2 Kg
Packaging size	33*27*31cm(6Pcs) 6.5kg

ROSE

MR-SL2 .5

Overhead installation



Option

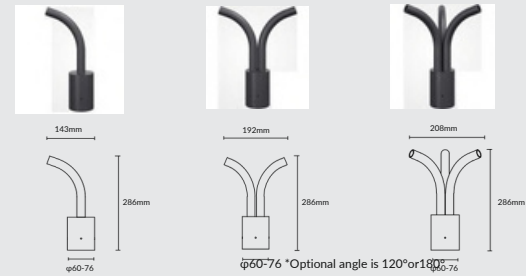

Candlestick

Material: steel
Suitable for φ60-76mm pole

light source*	lumen output (lm)	lumin. efficacy (lm/w)	light beam options
3000°K warm-white 10W COB	960.0	96.00	15°
			24°
15W COB	1440.0		36°
20W COB	1920.0		60°
			40*70°

2700/4000/5000K CCT available on request

Finish color options :

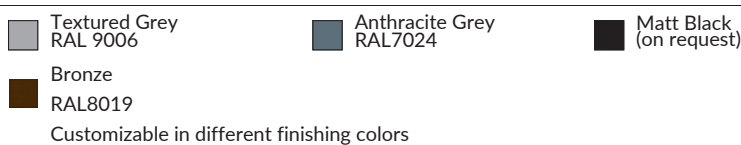



Mora

Professional Lighting

Technical features



Technical data

Wattage	30/40/60W
IP Rating	IP66
IK Rating	IK06
Material	High corrosion resistance die-cast copper-free aluminum body
Coating	Polyester powder coating with phosphochromating pre-finish
Light source	1 x COB CRI>90
Screws	Stainless steel
Transformer	Electronic power supply 220/240V 50/60Hz built-in or AC120-277V
Gasket	Silicone rubber
Glass	Tempered
Power cable	0.5 mt. neoprene power cable included
Gross weight	2.15 Kg
Packaging size	32*32*42cm 4PCS 8.6kg

ROSE Pro

MR-SL3 .5

Overhead installation



Option

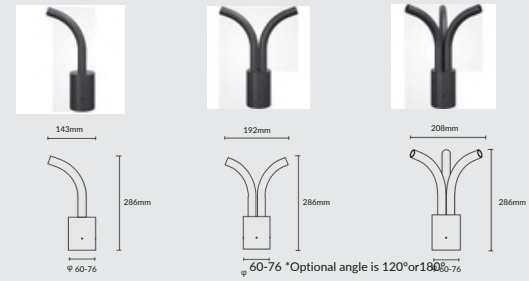

Candlestick
Material: steel
Suitable for φ60-76mm pole

light source*	lumen output (lm)	lumin. efficacy (lm/w)	light beam options
3000°K warm-white 30W COB	3000.0	100.00	15°
			24°
40W COB	4000.0		36°
60W COB	6000.0		40*70°

2700/4000/5000K CCT available on request

Finish color options :

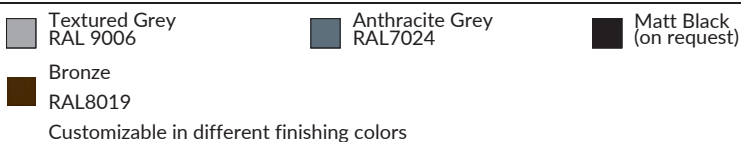

Technical features



Technical data

Wattage	30/40/60W
IP Rating	IP66
IK Rating	IK06
Material	High corrosion resistance die-cast copper-free aluminum body
Coating	Polyester powder coating with phosphochromating pre-finish
Light source	1 x COB CRI>90
Screws	Stainless steel
Transformer	Electronic power supply 220/240V 50/60Hz built-in or(AC120-277V)/(DC12-24V)
Gasket	Silicone rubber
Glass	Tempered
Power cable	0.5 mt. neoprene power cable included
Gross weight	2.15 Kg
Packaging size	32*32*42cm 4PCS 8.6kg



ROSE Pro

MR-SL3 .6

Flange installation

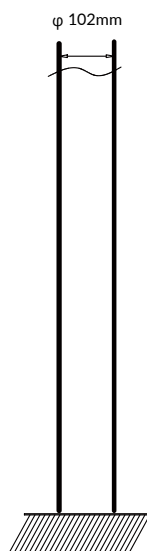
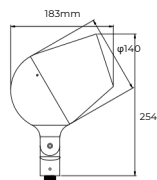

Option



Unilateral flange
Material: Die cast aluminum



Bilateral flange



light source*	lumen output (lm)	lumin. efficacy (lm/w)	light beam options
3000°K warm-white 30W COB	3000.0	100.00	15°
			24°
40W COB	4000.0		36°
60W COB	6000.0		40*70°

2700/4000/5000K CCT available on request

Finish color options :

- Textured Grey
RAL 9006
- Anthracite Grey
RAL7024
- Matt Black
(on request)
- Bronze

Customizable in different finishing colors



Technical features



Technical data

Wattage	30/40/60W
IP Rating	IP66
IK Rating	IK06
Material	High corrosion resistance die-cast copper-free aluminum body
Coating	Polyester powder coating with phosphochromating pre-finish
Light source	1 x COB CRI>90
Screws	Stainless steel
Transformer	Electronic power supply 220/240V 50/60Hz built-in or(AC120-277V)/(DC12-24V)
Gasket	Silicone rubber
Glass	Tempered
Power cable	0.5 mt. neoprene power cable included
Gross weight	2.15 Kg
Packaging size	32*32*42cm 4PCS 8.6kg

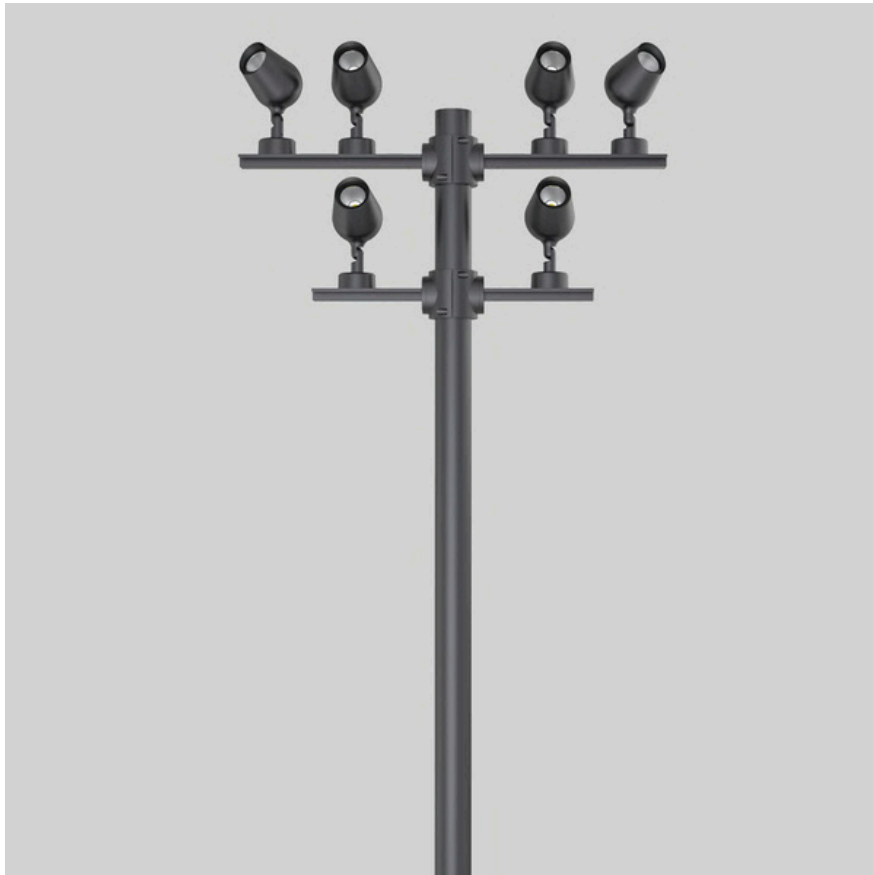

ROSE Pro

MR-SL3 .7

Flange(bracket) installation

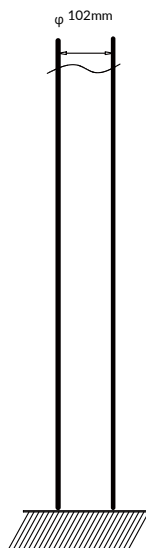
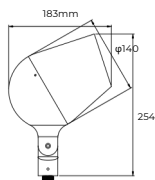

Option



Unilateral flange(bracket)
Material: Die cast aluminum/aluminum profile



Bilateral flange(bracket)

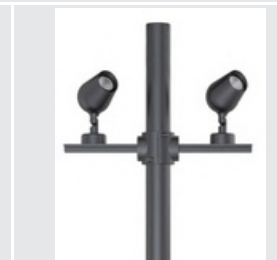

light source*	lumen output (lm)	lumin. efficacy (lm/w)	light beam options
3000°K warm-white			
30W COB	3000.0	100.00	15°
40W COB	4000.0		24°
60W COB	6000.0		36°
			40*70°

2700/4000/5000K CCT available on request

Finish color options :

- Textured Grey RAL 9006
- Anthracite Grey RAL7024
- Matt Black (on request)
- Bronze

Customizable in different finishing colors



NEW



Mora

Professional Lighting

Technical features



Technical data

Wattage	30/40/60W
IP Rating	IP66
IK Rating	IK06
Material	High corrosion resistance die-cast copper-free aluminum body
Coating	Polyester powder coating with phosphochromating pre-finish
Light source	1 x COB CRI>90
Screws	Stainless steel
Transformer	Electronic power supply 220/240V 50/60Hz built-in or(AC120-277V)/(DC12-24V)
Gasket	Silicone rubber
Glass	Tempered
Power cable	0.5 mt. neoprene power cable included
Gross weight	2.15 Kg
Packaging size	32*32*42cm 4PCS 8.6kg

ROSE Pro

MR-SL3 .8

Kingfisher/Installing Lamp Arm



Option

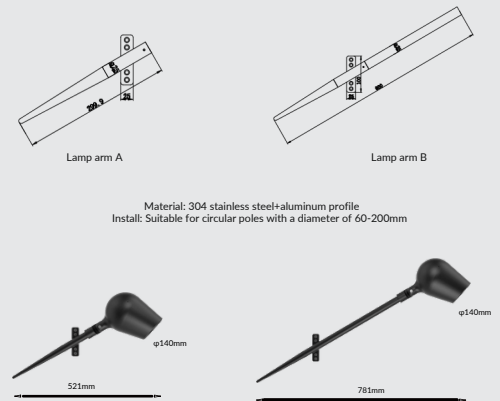

light source*	lumen output (lm)	lumin. efficacy (lm/w)	light beam options
3000°K warm-white			
30W COB	3000.0	100.00	15°
40W COB	4000.0		24°
60W COB	6000.0		36°
			60°
			40*70°

2700/4000/5000K CCT available on request

Finish color options :

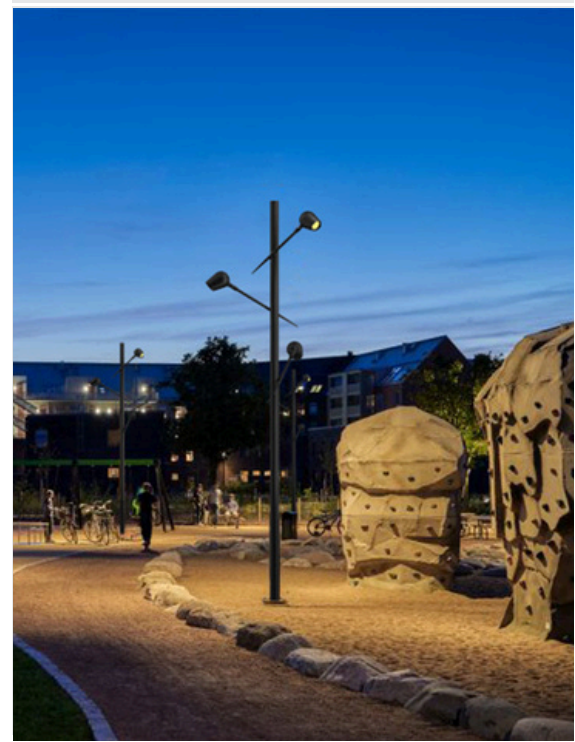
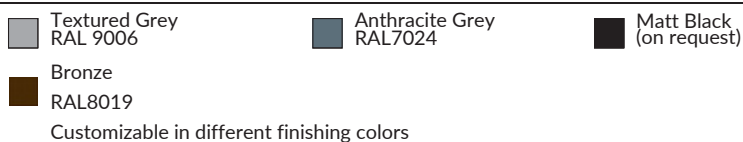



Technical data

Wattage	10/15/20W
IP Rating	IP66
IK Rating	IK06
Material	High corrosion resistance die-cast copper-free aluminum body
Coating	Polyester powder coating with phosphochromating pre-finish
Light source	1 x COB CRI>90
Screws	Stainless steel
Transformer	Electronic power supply 220/240V 50/60Hz built-in or(AC120-277V)/(DC12-24V)
Gasket	Silicone rubber
Glass	Tempered
Power cable	0.5 mt. neoprene power cable included
Gross weight	1.2 Kg
Packaging size	33*27*31cm(6Pcs) 6.5kg



ROSE

MR-SL2 .6

Sign Light

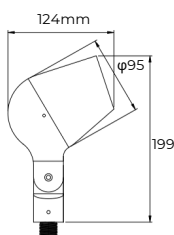
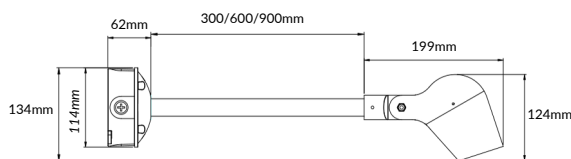

OPTION

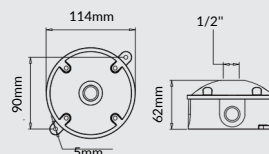

JB Junction Box

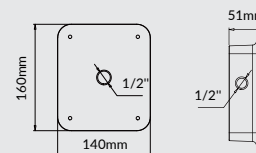

WM Wall Mount

Extension arm

Material: Aluminum profile
Specification: Thickness 4mmφ 25mm
*Length can be customized



light source*	lumen output (lm)	lumin. efficacy (lm/w)	light beam options
3000°K warm-white 10W COB	960.0	96.00	15°
			24°
15W COB			36°
20W COB			40*70°

2700/4000/5000K CCT available on request

Finish color options :

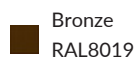

Customizable in different finishing colors



BOLLARDS AND URBAN LIGHTING

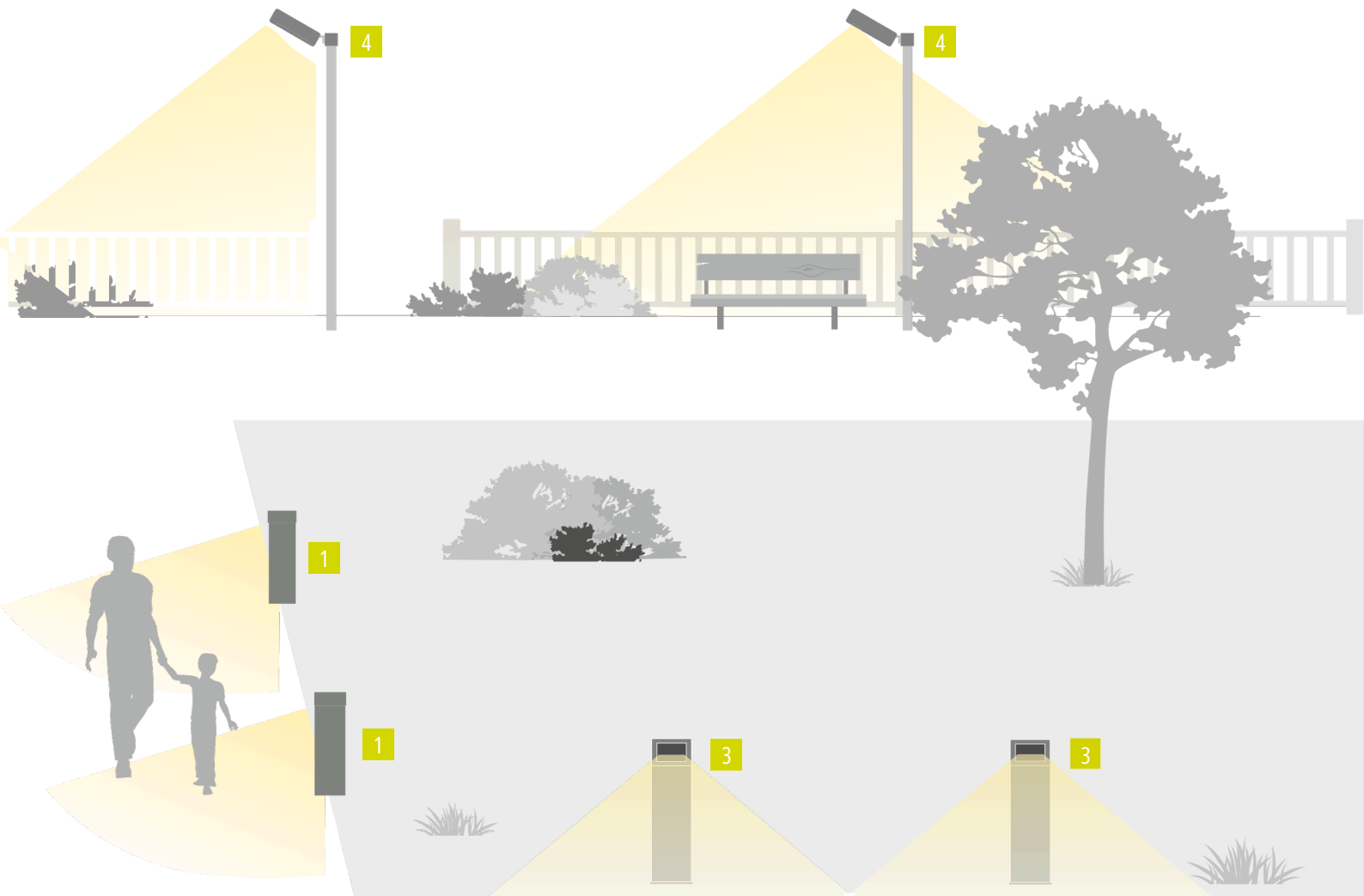



Technical data

Wattage	100/150/200W
IP Rating	IP65
IK Rating	IK06
Material	High corrosion resistance die-cast copper-free aluminum body
Coating	Polyester powder coating with phosphocromating pre-finish
Light source	144/200/288 x 3030LED CRI>80
Standard Deviation Color Matching :MacAdam step 3	
Screws	Stainless steel
Transformer	Electronic power supply 220/240V 50/60Hz built-in or AC120-277V
Gasket	Silicone rubber
Glass	Tempered
Power cable	0.5 mt. neoprene power cable included
Gross weight	5.5 Kg



MR-OK

The LTOK LED area/site luminaire delivers exceptional performance in a scalable, low-profile design. The precision engineered optics provide uniform illumination to walkways, parking lots, roadways, building areas and security lighting applications. Backed by a five-year limited warranty, the LTOK LED area/site luminaire is the LED answer to your area and site lighting needs.

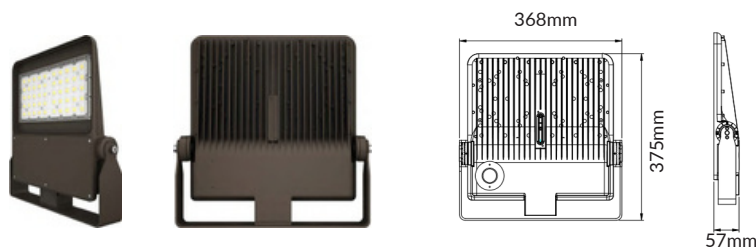

light source*	lumen output (lm)	lumin. efficacy (lm/w)	light beam options
5000°K white LT-OK-100W	14000.0	140.0	Symmetry 135°
LT-OK-150W	21000.0		Asymmetric TYPE III(73x149°)
LT-OK-200W	28000.0		Asymmetric TYPE IV(86x153°)

3000/4000K CCT available on request

Finish color options :

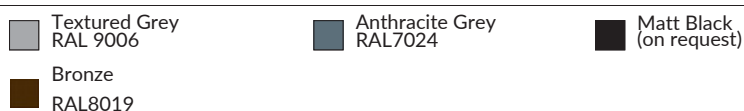

Customizable in different finishing colors

Option



Photocell

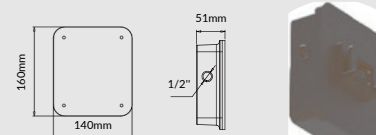

Wall Mount

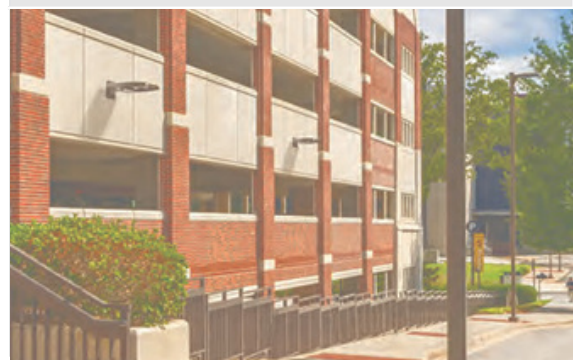



Technical data

Wattage	300W
IP Rating	IP65
IK Rating	IK06
Material	High corrosion resistance die-cast copper-free aluminum body
Coating	Polyester powder coating with phosphocromating pre-finish
Light source	464 x 3030LED CRI>80
Standard Deviation Color Matching	:MacAdam step 3
Screws	Stainless steel
Transformer	Electronic power supply 220/240V 50/60Hz built-in or AC120-277V
Gasket	Silicone rubber
Glass	Tempered
Power cable	0.5 mt. neoprene power cable included
Gross weight	8.4Kg

MR-OK

The LTOK LED area/site luminaire delivers exceptional performance in a scalable, low-profile design. The precision engineered optics provide uniform illumination to walkways, parking lots, roadways, building areas and security lighting applications. Backed by a five-year limited warranty, the LTOK LED area/site luminaire is the LED answer to your area and site lighting needs.

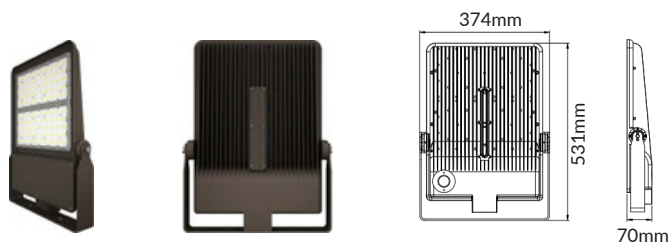

light source*	lumen output (lm)	lumin. efficacy (lm/w)	light beam options
5000°K white			Symmetry 135°
LT-OK-300W	42000.0	140.0	Asymmetric TYPE III(73x149°) Asymmetric TYPE IV(86x153°)

3000/4000K CCT available on request

Finish color options :

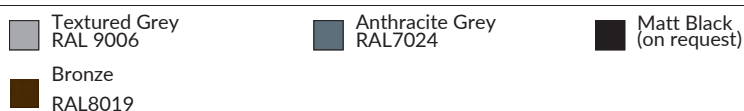

Customizable in different finishing colors

Option



Photocell

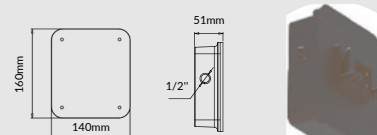

Wall Mount





Technical data

Wattage	5W
IP Rating	IP65
IK Rating	IK08
Material	High corrosion resistance die-cast copper-free aluminum body +Aluminum profile
Coating	Polyester powder coating with phosphochromating pre-finish
Light source	4x5050LED CRI>80
Standard Deviation Color Matching :MacAdam step 3	
Screws	Stainless steel
Transformer	Electronic power supply 220/240V 50/60Hz built-in or AC120-277V/DC12-24V
Gasket	Silicone rubber
Glass	Tempered
Power cable	1 mt. neoprene power cable included
Gross weight	(0.6m)4.5 Kg (0.8m)5.5 Kg (1m)6.5 Kg
Package size	(0.6m)66*23*22cm (0.8m)86*23*22cm (1m)106*23*22cm

LAUGH

MR-BL

A series of LED light building elements with asymmetrical light distribution.

Light building elements are luminous design features for public areas.

They are ideally suited for delineating and structuring interior and exterior spaces such as landscape areas, plazas, building entrances

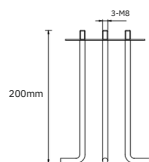
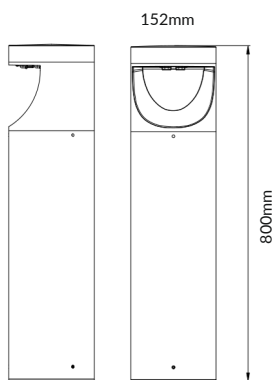

Concrete anchor 1023
Material: steel
*Need to be purchased separately

light source*	lumen output (lm)	lumin. efficacy (lm/w)	light beam options
5000K white			
LT-BL-5W	450.0	80.0	Asymmetric (70x150°)
3000/4000K CCT available on request			Unilateral light output

Finish color options :

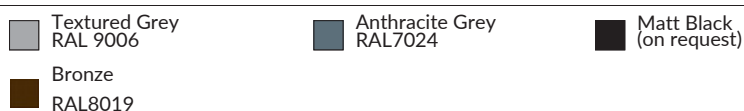

Customizable in different finishing colors

IES DISTRIBUTIONS (OPTION)

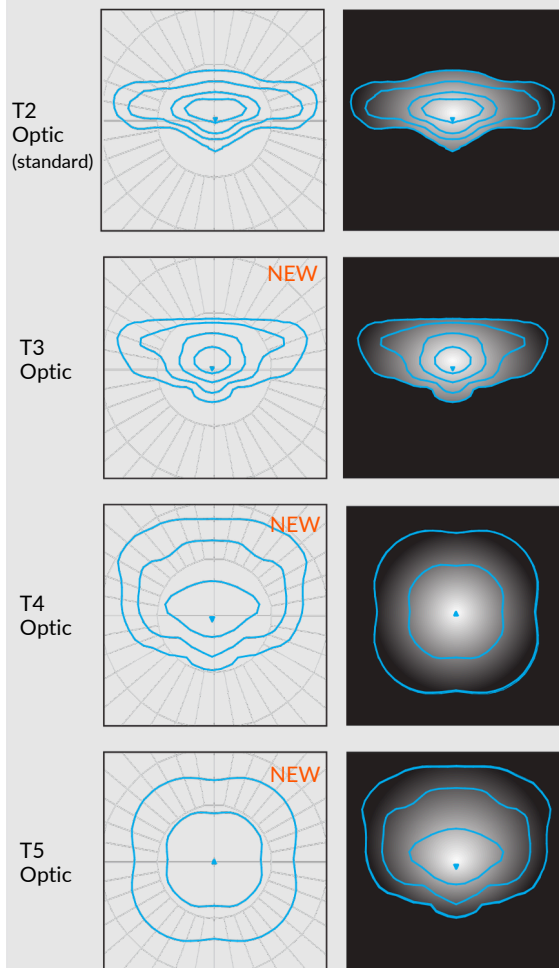



Technical data

Wattage	24W
IP Rating	IP65
IK Rating	IK08
Material	High corrosion resistance die-cast copper-free aluminum body +Aluminum profile
Coating	Polyester powder coating with phosphochromating pre-finish
Light source	8x5050LED CRI>80
Standard Deviation Color Matching	:MacAdam step 3
Screws	Stainless steel
Transformer	Electronic power supply 220/240V 50/60Hz built-in or AC120-277V/DC12-24V
Gasket	Silicone rubber
Glass	Tempered
Power cable	1 mt. neoprene power cable included
Gross weight	(0.6m)4.5 Kg (0.8m)5.5 Kg (1m)6.5 Kg
Package size	(0.6m)66*23*22cm (0.8m)86*23*22cm (1m)106*23*22cm



LAUGH

MR-BL

A series of LED light building elements with asymmetrical light distribution. Light building elements are luminous design features for public areas. They are ideally suited for delineating and structuring interior and exterior spaces such as landscape areas, plazas, building entrances

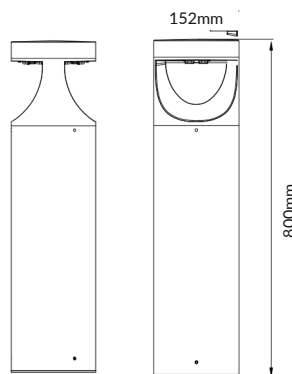

Concrete anchor 1023
Material: steel
*Need to be purchased separately



light source*	lumen output (lm)	lumin. efficacy (lm/w)	light beam options
5000K white			
LT-BL-24W	1920.0	80.0	Asymmetric 2*(70x150°)
3000/4000K CCT available on request			Bilateral light output

Finish color options :

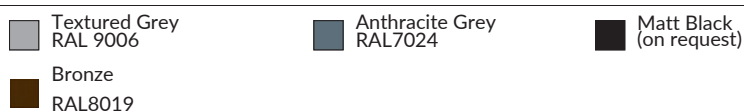

Customizable in different finishing colors

IES DISTRIBUTIONS (OPTION)

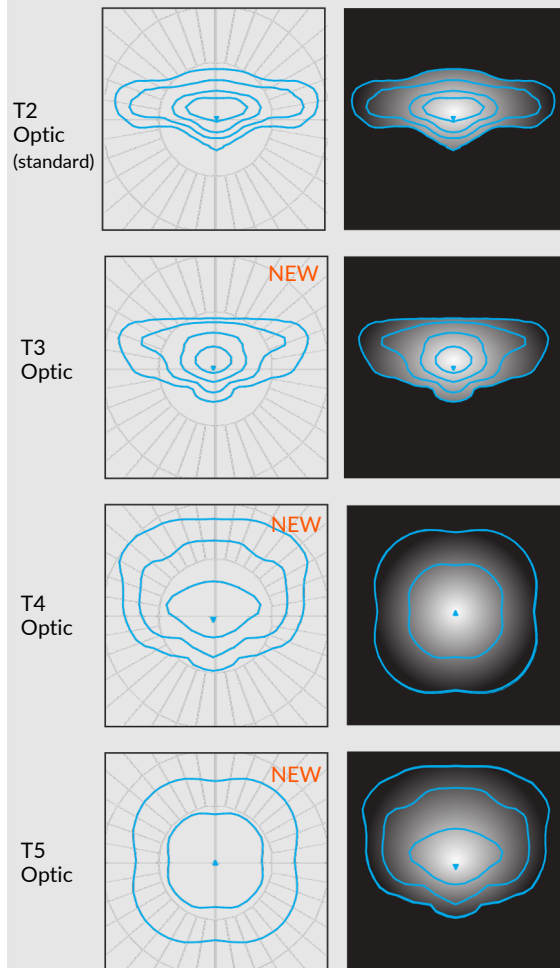



NEW



Create biologically sustainable lighting with Amber lenses

Eliminate blue light and provide always warm colours with white light LEDs.

Us and those around us

We are constantly increasing our knowledge about what good lighting is and want to remain at the forefront in providing the best optical solutions to enhance well-being for both ourselves and the ecosystem around us. In urban environments illumination itself, or sudden changes to it, can influence how nocturnal fauna behave. Some species of both flora and fauna are especially sensitive to changes in brightness levels or light wavelengths, as they influence how they communicate, navigate, or reproduce. Many species are especially sensitive to the lower part (blue light) of the spectrum from 380 to 500 nanometres which should be avoided where possible

the data

Conclusion

Amber lenses cut down the blue light spectrum from white light LEDs to provide safer lighting for night-time surroundings.

Compared to a typical 6000 lm park luminaire the savings in luminaire component cost with AMBER lenses is around half that of amber coloured LEDs with clear lenses. (To achieve the same lumen output only half as many LEDs and optics are needed). This results in a more compact luminaire design and less pressure on our environment.

Technical features



Technical data

Wattage	12W
IP Rating	IP65
IK Rating	IK08
Material	High corrosion resistance die-cast copper-free aluminum body + Aluminum profile
Coating	Polyester powder coating with phosphochromating pre-finish
Light source	18x2835LED CRI>80
Standard Deviation Color Matching :MacAdam step 3	
Screws	Stainless steel
Transformer	Electronic power supply 220/240V 50/60Hz built-in or AC120-277V/DC12-24V
Gasket	Silicone rubber
Glass	Tempered
Power cable	1 mt. neoprene power cable included
Gross weight	(0.6m)4.5 Kg (0.8m)5.5 Kg (1m)6.5 Kg
Package size	(0.6m)66*23*22cm (0.8m)86*23*22cm (1m)106*23*22cm



ECLIPSE

MR-YS

Super comfort, no glare at all
 180° and 360° symmetrical light distribution
 Die-cast aluminum fixture with polyester powder coating on the surface
 IK08 IP65 protection level
 Multiple installation options

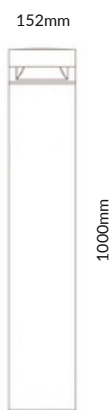

Option

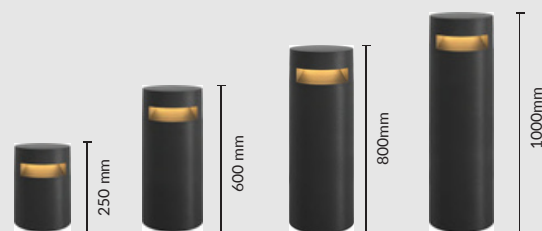

light source*	lumen output (lm)	lumin. efficacy (lm/w)	light beam options
5000K white			
MR-YS-12W	497.0	42.0	Symmetry 180°

3000/4000K CCT available on request

Finish color options :

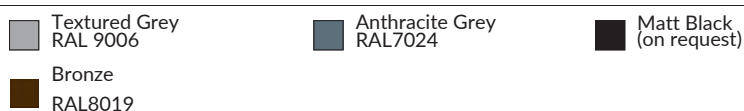

Customizable in different finishing colors

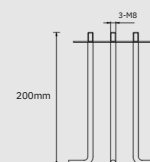

Concrete anchor 1023
 Material: steel
 *Need to be purchased separately



Technical features



360°

Technical data

Wattage	24W
IP Rating	IP65
IK Rating	IK08
Material	High corrosion resistance die-cast copper-free aluminum body +Aluminum profile
Coating	Polyester powder coating with phosphochromating pre-finish
Light source	24x2835LED CRI>80
Standard Deviation Color Matching :MacAdam step 3	
Screws	Stainless steel
Transformer	Electronic power supply 220/240V 50/60Hz built-in or AC120-277V/DC12-24V
Gasket	Silicone rubber
Glass	Tempered
Power cable	1 mt. neoprene power cable included
Gross weight	(0.6m)4.5 Kg (0.8m)5.5 Kg (1m)6.5 Kg
Package size	(0.6m)66*23*22cm (0.8m)86*23*22cm (1m)106*23*22cm

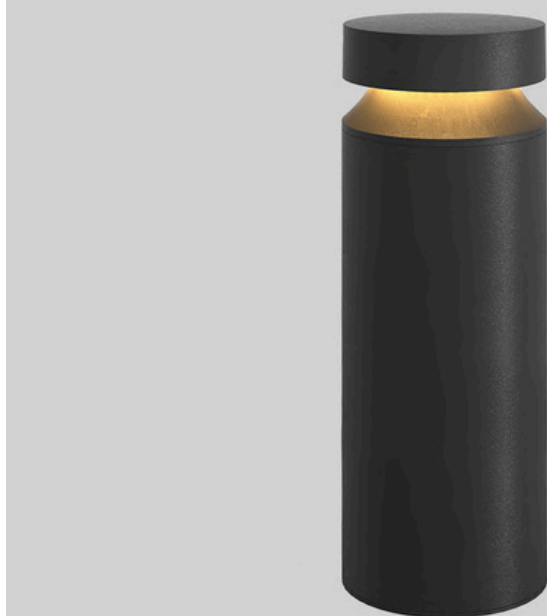

ECLIPSE

MR-YS

Super comfort, no glare at all
 180° and 360° symmetrical light distribution
 Die-cast aluminum fixture with polyester powder coating on the surface
 IK08 IP65 protection level
 Multiple installation options

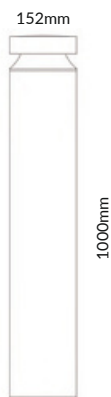

Option

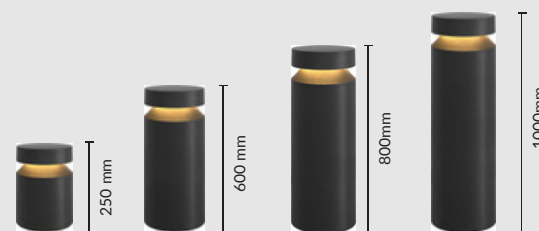

light source*	lumen output (lm)	lumin. efficacy (lm/w)	light beam options
5000K white			
MR-YS-24W	1008.0	42.0	Symmetry (360°)

3000/4000K CCT available on request

Finish color options :

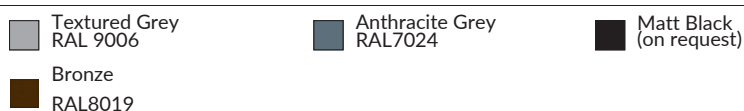

Customizable in different finishing colors

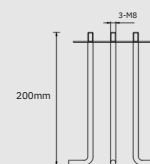

Concrete anchor 1023
 Material: steel
 *Need to be purchased separately



Technical features



360°

Technical data

Wattage	10W
IP Rating	IP65
IK Rating	IK08
Material	High corrosion resistance die-cast copper-free aluminum body +Aluminum profile
Coating	Polyester powder coating with phosphochromating pre-finish
Light source	24x2835LED CRI>80
Standard Deviation Color Matching	:MacAdam step 3
Screws	Stainless steel
Transformer	Electronic power supply 220/240V 50/60Hz built-in or AC120-277V/DC12-24V
Gasket	Silicone rubber
Glass	Tempered
Power cable	1 mt. neoprene power cable included

ECLIPSE

MR-YS

Super comfort, no glare at all

180° and 360° symmetrical light distribution

Die-cast aluminum fixture with polyester powder coating on the surface

IK08 IP65 protection level

Multiple installation options

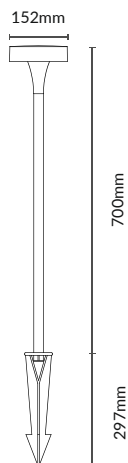

light source*	lumen output (lm)	lumin. efficacy (lm/w)	light beam options
5000K white			
MR-YS-10W	700.0	70.0	Symmetry 360°

3000/4000K CCT available on request

Finish color options :

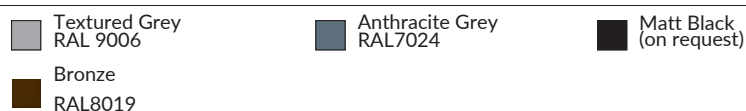

Customizable in different finishing colors

Option

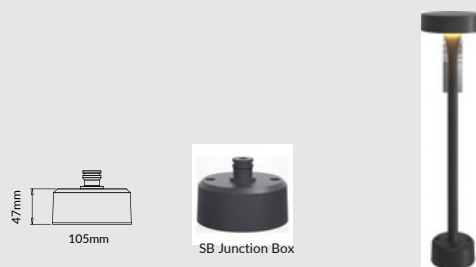
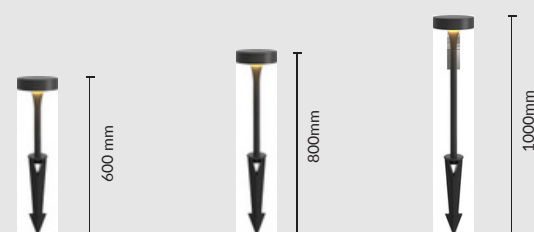

Technical features



Technical data

Wattage	7W
IP Rating	IP66
IK Rating	IK06
Material	High corrosion resistance die-cast copper-free aluminum body
Coating	Polyester powder coating with phosphochromating pre-finish
Light source	1 x COB CRI>80
Standard Deviation Color Matching	:MacAdam step 3
Screws	Stainless steel
Transformer	Electronic power supply AC120-277V or DC12-24V
Gasket	Silicone rubber
Glass	Tempered
Power cable	1 mt. neoprene power cable included



ROSE

MR-SLBOLLARD LIGHT 1.0

Small bollards for private gardens with various sizes and angles to choose from.

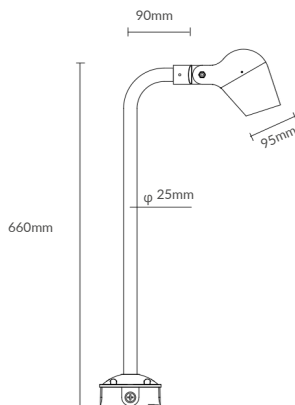

light source*	lumen output (lm)	lumin. efficacy (lm/w)	light beam options										
3000°K warm-white													
7W COB	700.0	100.0	<table border="1"> <tr> <td></td> <td>15°</td> </tr> <tr> <td></td> <td>24°</td> </tr> <tr> <td></td> <td>36°</td> </tr> <tr> <td></td> <td>60°</td> </tr> <tr> <td></td> <td>40°-70°</td> </tr> </table>		15°		24°		36°		60°		40°-70°
	15°												
	24°												
	36°												
	60°												
	40°-70°												

2700/4000/5000K CCT available on request

Finish color options :

- Textured Grey
RAL 9006
- Anthracite Grey
RAL7024
- Matt Black
(on request)
- Bronze
RAL8019

Customizable in different finishing colors

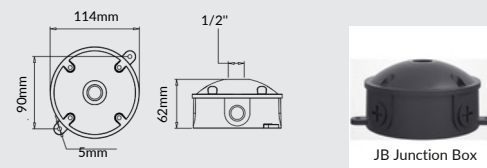

JB Junction Box

Extension arm

Material: Aluminum profile
Specification: Thickness 4mmφ 25mm
*Length can be customized



Technical features



Technical data

Wattage	20W
IP Rating	IP66
IK Rating	IK06
Material	High corrosion resistance die-cast copper-free aluminum body
Coating	Polyester powder coating with phosphochromating pre-finish
Light source	1 x COB CRI>90
Standard Deviation Color Matching	:MacAdam step 3
Screws	Stainless steel
Transformer	Electronic power supply AC120-277V or DC12-24V
Gasket	Silicone rubber
Glass	Tempered
Power cable	1 mt. neoprene power cable included
Gross weight	4.5 Kg



ROSE

MR-SLBOLLARD LIGHT 2.0

1000mm height bollard, taper shape, for outdoor surface installation, multiple angle glow options, phosphochromatised and polyester powder coated die-cast copper-free aluminium body, polycarbonate diffuser, moulded silicone gasket and stainless steel screws. Anchorage bolts included. Built-in LED driver IP66 rating.

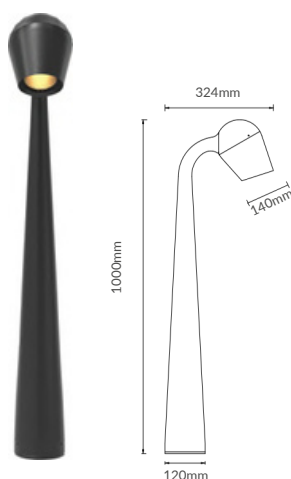

Option

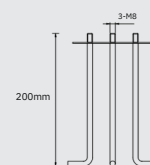

Concrete anchor 1023
Material: steel
*Need to be purchased separately

light source*	lumen output (lm)	lumin. efficacy (lm/w)	light beam options										
3000°K warm-white													
20W COB	2000.0	100.0	<table border="1"> <tr> <td></td> <td>15°</td> </tr> <tr> <td></td> <td>24°</td> </tr> <tr> <td></td> <td>36°</td> </tr> <tr> <td></td> <td>60°</td> </tr> <tr> <td></td> <td>40°-70°</td> </tr> </table>		15°		24°		36°		60°		40°-70°
	15°												
	24°												
	36°												
	60°												
	40°-70°												

2700/4000/5000K CCT available on request

Finish color options :

- Textured Grey
RAL 9006
- Anthracite Grey
RAL7024
- Matt Black
(on request)
- Bronze
RAL8019

Customizable in different finishing colors





Technical data

Wattage	10W
IP Rating	IP65
IK Rating	IK06
Material	High corrosion resistance die-cast copper-free aluminum body +Aluminum profile
Coating	Polyester powder coating with phosphochromating pre-finish
Light source	24x2835LED CRI>80
Standard Deviation Color Matching	:MacAdam step 3
Screws	Stainless steel
Transformer	Electronic power supply 220/240V 50/60Hz built-in or AC120-277V/DC12-24V
Gasket	Silicone rubber
Glass	Tempered
Power cable	1 mt. neoprene power cable included
Gross weight	2 Kg

SHADOW

MR-YZ

The luminaire is designed on the principle of a reflective three-screen system, which directs the light downwards. The screens have a matte, white, lacquered inside, which diffuses the light so that it becomes comfortable to look at.

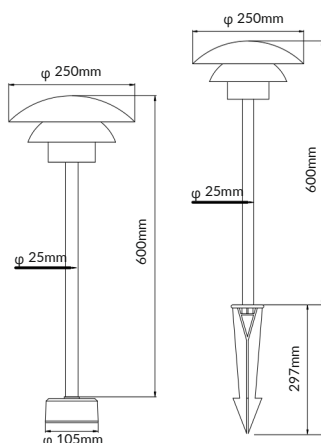

Option

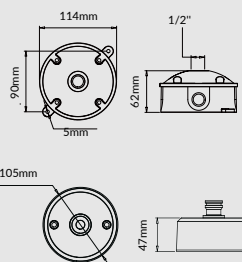
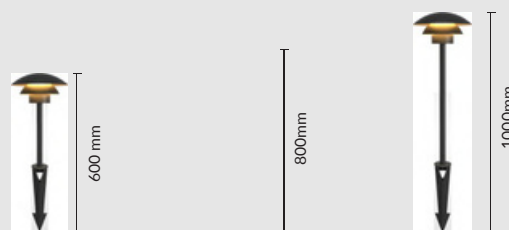

light source*	lumen output (lm)	lumin. efficacy (lm/w)	light beam options
5000K white			
MR-YS-10W	464.0	46.4	Indirect luminescence

3000/4000K CCT available on request

Finish color options :

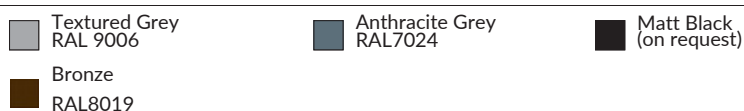

Customizable in different finishing colors

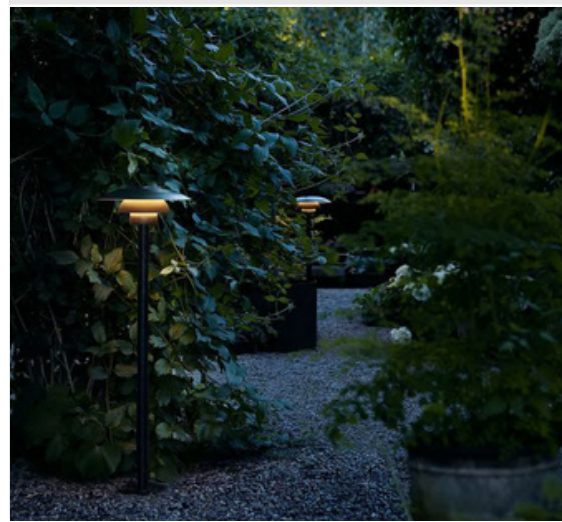



Technical data

Wattage	10W
IP Rating	IP65
IK Rating	IK06
Material	High corrosion resistance die-cast copper-free aluminum body +Aluminum profile
Coating	Polyester powder coating with phosphochromating pre-finish
Light source	24x2835LED CRI> 80
Standard Deviation Color Matching	:MacAdam step 3
Screws	Stainless steel
Transformer	Electronic power supply 220/240V 50/60Hz built-in or AC120-277V/DC12-24V
Gasket	Silicone rubber
Glass	Tempered
Power cable	1 mt. neoprene power cable included
Gross weight	2 Kg



SHADOW

MR-YZ

The luminaire is designed on the principle of a reflective three-screen system, which directs the light downwards. The screens have a matte, white, lacquered inside, which diffuses the light so that it becomes comfortable to look at.

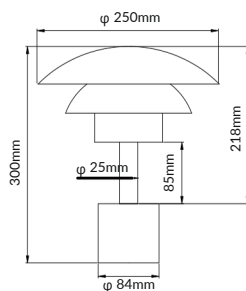

light source*	lumen output (lm)	lumin. efficacy (lm/w)	light beam options
5000K white			
MR-YS-10W	464.0	46.4	Indirect luminescence

3000/4000K CCT available on request

Finish color options :

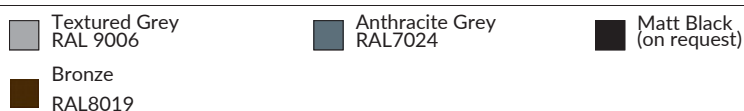

Customizable in different finishing colors

Option



φ 60mm



φ 76mm

Material: Steel, surface hot-dip galvanized treatment and polyester powder spraying

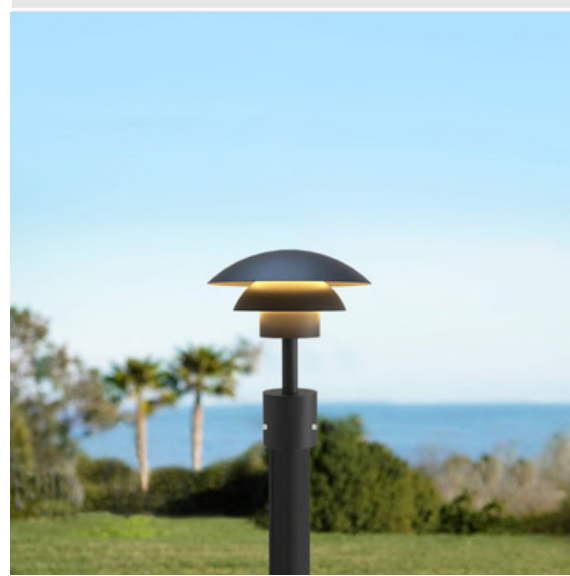

Mora®
Professional Lighting

STEP LIGHT





Technical data

Wattage	6W
IP Rating	IP65
IK Rating	IK06
Material	High corrosion resistance die-cast copper-free aluminum body
Coating	Polyester powder coating with phosphochromating pre-finish
Light source	12x2835LED CRI>80
Standard Deviation Color Matching	:MacAdam step 3
Screws	Stainless steel
Transformer	Electronic power supply 220/240V 50/60Hz built-in
Gasket	Silicone rubber
Glass	Tempered
Power Cables	Internal wiring
Gross weight	1 Kg

STEP LIGHT

MR-TJ-Y512

Lighting system for walkways designed for use with LED light sources to ensure high visual comfort.
Wall installation.
Built-in LED driver

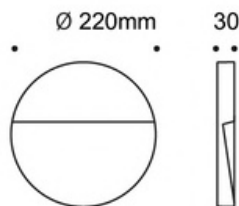

Polar Coordinate Light Distribution Curve

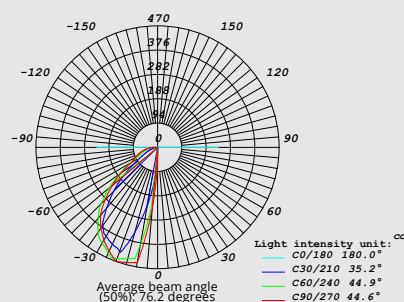

Cartesian coordinate light distribution curve
Light intensity distribution curve

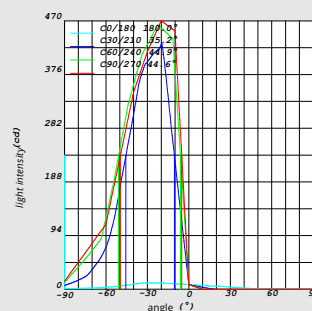

light source*	lumen output (lm)	lumin. efficacy (lm/w)	light beam options
5000K white			
MR-TJ-F512-6W	464.0	76.0	Asymmetric

3000/4000K CCT available on request

Finish color options :

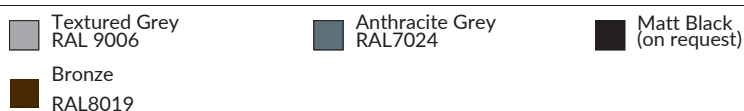

Customizable in different finishing colors





Technical data

Wattage	6W
IP Rating	IP65
IK Rating	IK06
Material	High corrosion resistance die-cast copper-free aluminum body
Coating	Polyester powder coating with phosphochromating pre-finish
Light source	12x2835LED CRI>80
Standard Deviation Color Matching	:MacAdam step 3
Screws	Stainless steel
Transformer	Electronic power supply 220/240V 50/60Hz built-in
Gasket	Silicone rubber
Glass	Tempered
Power Cables	Internal wiring
Gross weight	1 Kg

STEP LIGHT

MR-TJ-F512

Lighting system for walkways designed for use with LED light sources to ensure high visual comfort. Wall installation. Built-in LED driver

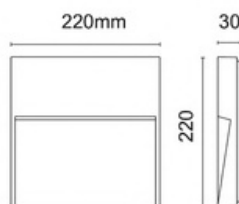

Polar Coordinate Light Distribution Curve

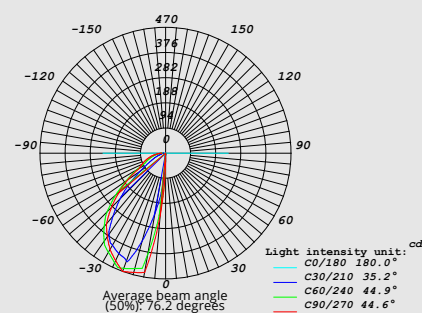

Cartesian coordinate light distribution curve

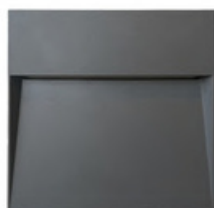
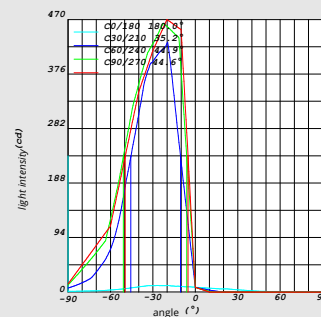

light source*	lumen output (lm)	lumin. efficacy (lm/w)	light beam options
5000K white			
MR-TJ-F512-6W	464.0	76.0	Asymmetric

3000/4000K CCT available on request

Finish color options :

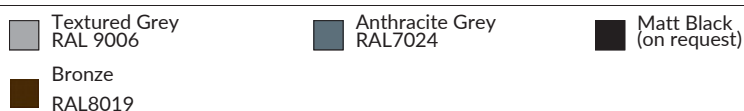

Customizable in different finishing colors



PORTABLE TABLE LIGHTS



Technical features



360°

Technical data

Wattage	2.5W
IP Rating	IP65
IK Rating	IK06
Material	High corrosion resistance die-cast copper-free aluminum body
Coating	Polyester powder coating with phosphochromating pre-finish
Light source	12x2835 LED CRI>90
Standard Deviation Color Matching	:MacAdam step 3
Screws	Stainless steel
Battery	5000MA.H
Standby time	8h
Glass	Tempered
Dimming	10-100%
Weight	2kg



ECLIPSE

MR-YS

Die-cast aluminum material
5000ma/h lithium battery
IP65 protection level
10-100% dimming range

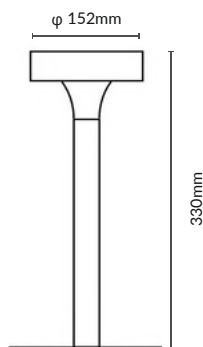

Option



Black



Rust



Red



TYPE-C usb line

light source*	lumen output (lm)	lumin. efficacy (lm/w)	light beam options
5000K white			
MR-YS-2.5W	100.0	40.0	Symmetry 360°

3000/4000K CCT available on request

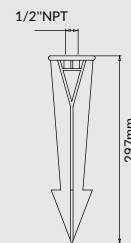
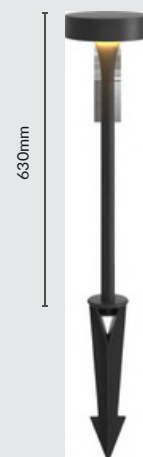

GS Ground Stake
Material: PC



URBAN LIGHTS





Technical data

Wattage	30/50W
IP Rating	IP65
IK Rating	IK08
Material	High corrosion resistance die-cast copper-free aluminum body
Coating	Polyester powder coating with phosphochromating pre-finish SMD high-intensity power LEDs
Light source	
Standard Deviation Color Matching :MacAdam step 3	
Screws	Stainless steel
Transformer	Electronic power supply 220/240V 50/60Hz built-in or AC120-277V
Gasket	Silicone rubber
Glass	Tempered
Power cable	1 mt. neoprene power cable included
Gross weight	7.3 Kg
Surge Protection	6 KV
Notes	Can on request DALI version available on request
Installation type	Smallpox



SUNFLOWER

MR-1885-30/50W

SunFlowers blurs the lines between outdoor and indoor

luminaires. A curb to cube family approach puts the focus on a variety of mounting options to cover a range of exterior and interior lighting needs. From roadways to pathways, public parks to university campuses, parking lots to lobbies, Sunflower has you covered. Mix and match lighting requirements with a consistent design aesthetic - outdoors and in.



light source*	lumen output (lm)	lumin. efficacy (lm/w)	light beam options
5000°K white LT-1885-30W	3390.0	113.0	105°
MR-1885-50W			

3000/4000K CCT available on request

Finish color options :

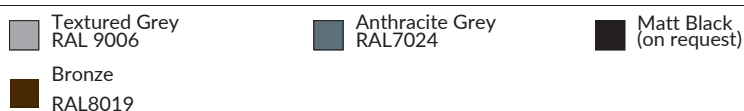

Customizable in different finishing colors





Technical data

Wattage	30/50W
IP Rating	IP65
IK Rating	IK08
Material	High corrosion resistance die-cast copper-free aluminum body
Coating	Polyester powder coating with phosphochromating pre-finish SMD high-intensity power LEDs
Light source	
Standard Deviation Color Matching :MacAdam step 3	
Screws	Stainless steel
Transformer	Electronic power supply 220/240V 50/60Hz built-in or AC120-277V
Gasket	Silicone rubber
Glass	Tempered
Power cable	1 mt. neoprene power cable included
Gross weight	7.3 Kg
Surge Protection	6 KV
Notes	Can on request DALI version available on request
Installation type	Pendant



SUNFLOWER

MR-1885-30/50W

SunFlowers blurs the lines between outdoor and indoor

luminaires. A curb to cube family approach puts the focus on a variety of mounting options to cover a range of exterior and interior lighting needs. From roadways to pathways, public parks to university campuses, parking lots to lobbies, Sunflower has you covered. Mix and match lighting requirements with a consistent design aesthetic - outdoors and in.



light source*	lumen output (lm)	lumin. efficacy (lm/w)	light beam options
5000°K white			
MR-1885-30W	3390.0	113.0	105°
MR-1885-50W	5650.0		

3000/4000K CCT available on request

Finish color options :

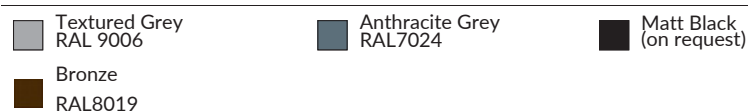

Customizable in different finishing colors





Technical data

Wattage	30/50/70/90W
IP Rating	IP65
IK Rating	IK08
Material	High corrosion resistance die-cast copper-free aluminum body
Coating	Polyester powder coating with phosphochromating pre-finish
Light source	SMD high-intensity power LEDs
Standard Deviation Color Matching	:MacAdam step 3
Screws	Stainless steel
Transformer	Electronic power supply 220/240V 50/60Hz built-in or AC120-277V
Gasket	Silicone rubber
Glass	Tempered
Power cable	1 mt. neoprene power cable included
Gross weight	8 Kg
Surge Protection	6 KV
Notes	Can on request DALI version available on request
Installation type	Wall

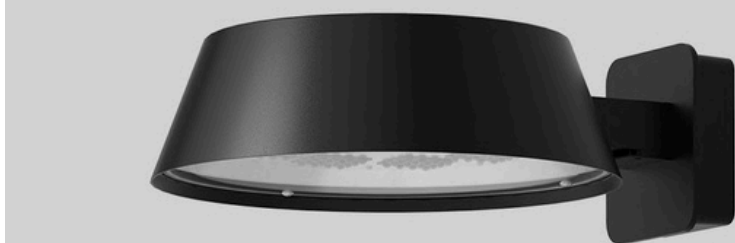

SUNFLOWER

MR-1885-30/50/70/90W

SunFlowers blurs the lines between outdoor and indoor luminaires. A curb to cube family approach puts the focus on a variety of mounting options to cover a range of exterior and interior lighting needs. From roadways to pathways, public parks to university campuses, parking lots to lobbies, Sunflower has you covered. Mix and match lighting requirements with a consistent design aesthetic - outdoors and in.

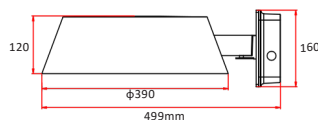

light source*	lumen output (lm)	lumin. efficacy (lm/w)	light beam options
5000°K white MR-1885-30W	4950.0	165.0	Type II
MR-1885-50W	8250.0		Type III
MR-1885-70W	11550.0		Type IV
MR-1885-90W	14850.0		Type V

3000/4000K CCT available on request

Finish color options :

- Textured Grey RAL 9006
- Anthracite Grey RAL7024
- Matt Black (on request)
- Bronze RAL8019

Customizable in different finishing colors

Option

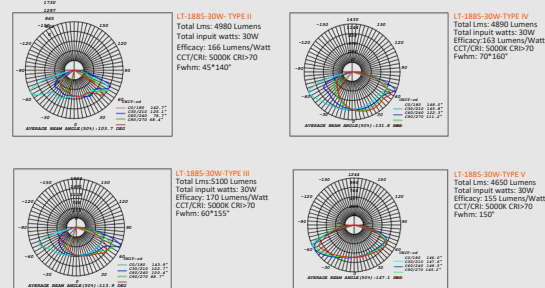



Technical data

Wattage	30/50/70/90W
IP Rating	IP65
IK Rating	IK08
Material	High corrosion resistance die-cast copper-free aluminum body
Coating	Polyester powder coating with phosphochromating pre-finish
Light source	SMD high-intensity power LEDs
Standard Deviation Color Matching	:MacAdam step 3
Screws	Stainless steel
Transformer	Electronic power supply 220/240V 50/60Hz built-in or AC120-277V
Gasket	Silicone rubber
Glass	Tempered
Power cable	1 mt. neoprene power cable included
Gross weight	7.5 Kg
Surge Protection	6 KV
Notes	Can on request DALI version available on request
Installation type	Wall



SUNFLOWER

MR-1885-30/50/70/90W

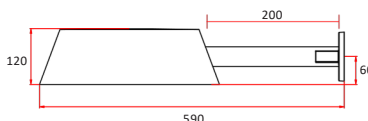

SunFlowers blurs the lines between outdoor and indoor luminaires. A curb to cube family approach puts the focus on a variety of mounting options to cover a range of exterior and interior lighting needs. From roadways to pathways, public parks to university campuses, parking lots to lobbies, Sunflower has you covered. Mix and match lighting requirements with a consistent design aesthetic - outdoors and in.



light source*	lumen output (lm)	lumin. efficacy (lm/w)	light beam options
5000°K white RM-1885-30W	4950.0	165.0	Type II
MR-1885-50W	8250.0		Type III
MR-1885-70W	11550.0		Type IV
MR-1885-90W	14850.0		Type V

3000/4000K CCT available on request

Finish color options :

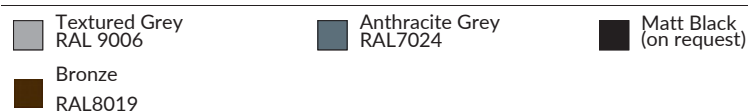

Customizable in different finishing colors

Option

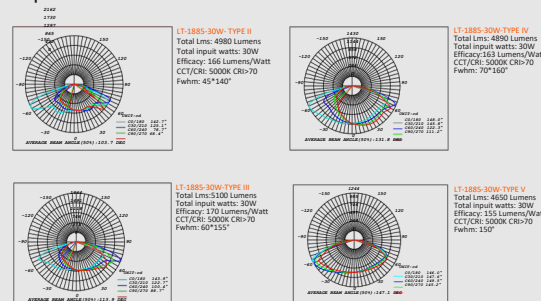



Technical data

Wattage	30/50/70/90W
IP Rating	IP65
IK Rating	IK08
Material	High corrosion resistance die-cast copper-free aluminum body
Coating	Polyester powder coating with phosphochromating pre-finish
Light source	SMD high-intensity power LEDs
Standard Deviation Color Matching	:MacAdam step 3
Screws	Stainless steel
Transformer	Electronic power supply 220/240V 50/60Hz built-in or AC120-277V
Gasket	Silicone rubber
Glass	Tempered
Power cable	1 mt. neoprene power cable included
Gross weight	7.5 Kg
Surge Protection	6 KV
Notes	Can on request DALI version available on request
Installation type	Overhead



SUNFLOWER

MR-1885-30/50/70/90W

SunFlowers blurs the lines between outdoor and indoor luminaires. A curb to cube family approach puts the focus on a variety of mounting options to cover a range of exterior and interior lighting needs. From roadways to pathways, public parks to university campuses, parking lots to lobbies, Sunflower has you covered. Mix and match lighting requirements with a consistent design aesthetic - outdoors and in.



Option

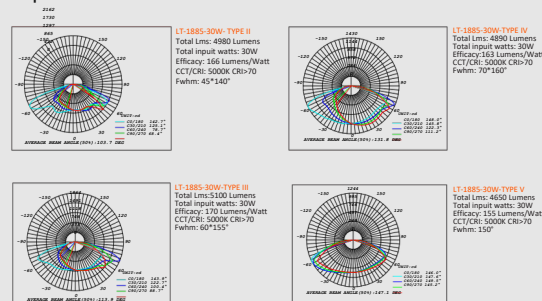

light source*	lumen output (lm)	lumin. efficacy (lm/w)	light beam options
5000°K white MR-1885-30W	4950.0	165.0	Type II
MR-1885-50W	8250.0		Type III
MR-1885-70W	11550.0		Type IV
MR-1885-90W	14850.0		Type V

3000/4000K CCT available on request

Finish color options :

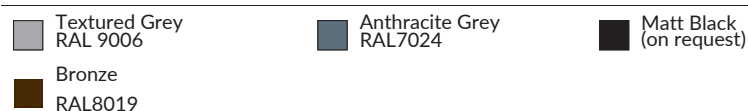

Customizable in different finishing colors





Technical data

Wattage	30/50/70/90W
IP Rating	IP65
IK Rating	IK08
Material	High corrosion resistance die-cast copper-free aluminum body
Coating	Polyester powder coating with phosphochromating pre-finish
Light source	SMD high-intensity power LEDs
Standard Deviation Color Matching	:MacAdam step 3
Screws	Stainless steel
Transformer	Electronic power supply 220/240V 50/60Hz built-in or AC120-277V
Gasket	Silicone rubber
Glass	Tempered
Power cable	1 mt. neoprene power cable included
Gross weight	8.1Kg
Surge Protection	6 KV
Notes	Can on request DALI version available on request
Installation type	Slip Fitter



SUNFLOWER

MR-1885-30/50/70/90W

SunFlowers blurs the lines between outdoor and indoor luminaires. A curb to cube family approach puts the focus on a variety of mounting options to cover a range of exterior and interior lighting needs. From roadways to pathways, public parks to university campuses, parking lots to lobbies, Sunflower has you covered. Mix and match lighting requirements with a consistent design aesthetic - outdoors and in.

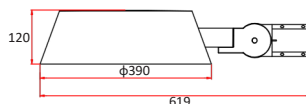

light source*	lumen output (lm)	lumin. efficacy (lm/w)	light beam options
5000°K white MR-1885-30W	4950.0	165.0	Type II
MR-1885-50W	8250.0		Type III
MR-1885-70W	11550.0		Type IV
MR-1885-90W	14850.0		Type V

3000/4000K CCT available on request

Finish color options :

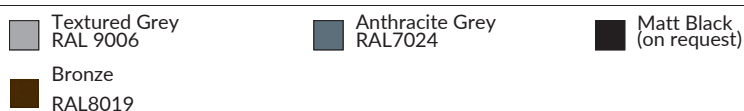

Customizable in different finishing colors

Option

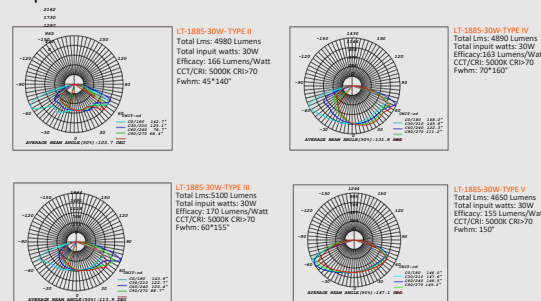



Technical data

Wattage	30/50/70/90W
IP Rating	IP65
IK Rating	IK08
Material	High corrosion resistance die-cast copper-free aluminum body
Coating	Polyester powder coating with phosphochromating pre-finish
Light source	SMD high-intensity power LEDs
Standard Deviation Color Matching	:MacAdam step 3
Screws	Stainless steel
Transformer	Electronic power supply 220/240V 50/60Hz built-in or AC120-277V
Gasket	Silicone rubber
Glass	Tempered
Power cable	1 mt. neoprene power cable included
Gross weight	7.3 Kg
Surge Protection	6 KV
Notes	Can on request DALI version available on request
Installation type	Pole Mount



SUNFLOWER

MR-1885-30/50/70/90W

SunFlowers blurs the lines between outdoor and indoor luminaires. A curb to cube family approach puts the focus on a variety of mounting options to cover a range of exterior and interior lighting needs. From roadways to pathways, public parks to university campuses, parking lots to lobbies, Sunflower has you covered. Mix and match lighting requirements with a consistent design aesthetic - outdoors and in.



light source*	lumen output (lm)	lumin. efficacy (lm/w)	light beam options
5000°K white MR-1885-30W	4950.0	165.0	Type II
MR-1885-50W	8250.0		Type III
MR-1885-70W	11550.0		Type IV
MR-1885-90W	14850.0		Type V

3000/4000K CCT available on request

Finish color options :

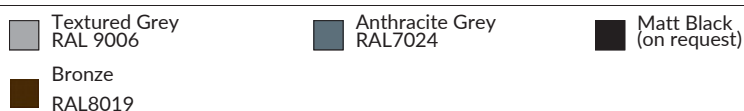

Customizable in different finishing colors

Option

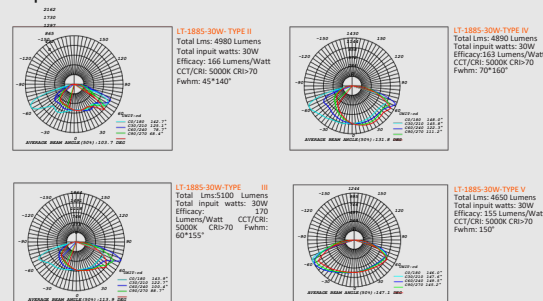



Technical data

Wattage	30/50/70/90W
IP Rating	IP65
IK Rating	IK08
Material	High corrosion resistance die-cast copper-free aluminum body
Coating	Polyester powder coating with phosphochromating pre-finish
Light source	SMD high-intensity power LEDs
Standard Deviation Color Matching	:MacAdam step 3
Screws	Stainless steel
Transformer	Electronic power supply 220/240V 50/60Hz built-in or AC120-277V
Gasket	Silicone rubber
Glass	Tempered
Power cable	1 mt. neoprene power cable included
Gross weight	7.5 Kg
Surge Protection	6 KV
Notes	Can on request DALI version available on request
Installation type	Pole Mount



SUNFLOWER

MR-1885-30/50/70/90W

SunFlowers blurs the lines between outdoor and indoor luminaires. A curb to cube family approach puts the focus on a variety of mounting options to cover a range of exterior and interior lighting needs. From roadways to pathways, public parks to university campuses, parking lots to lobbies, Sunflower has you covered. Mix and match lighting requirements with a consistent design aesthetic - outdoors and in.



light source*	lumen output (lm)	lumin. efficacy (lm/w)	light beam options
5000°K white MR-1885-30W	4950.0	165.0	Type II
MR-1885-50W	8250.0		Type III
MR-1885-70W	11550.0		Type IV
MR-1885-90W	14850.0		Type V

3000/4000K CCT available on request

Finish color options :

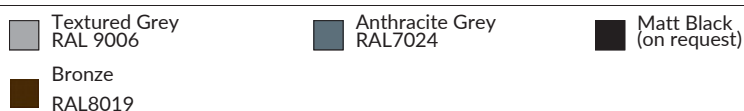

Customizable in different finishing colors

Option

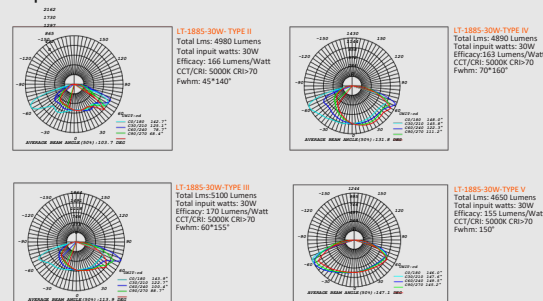



Technical data

Wattage	30/50/70/90W
IP Rating	IP65
IK Rating	IK08
Material	High corrosion resistance die-cast copper-free aluminum body
Coating	Polyester powder coating with phosphochromating pre-finish
Light source	SMD high-intensity power LEDs
Standard Deviation Color Matching	:MacAdam step 3
Screws	Stainless steel
Transformer	Electronic power supply 220/240V 50/60Hz built-in or AC120-277V
Gasket	Silicone rubber
Glass	Tempered
Power cable	1 mt. neoprene power cable included
Gross weight	7.3 Kg
Surge Protection	6 KV
Notes	Can on request DALI version available on request
Installation type	Pole Mount

SUNFLOWER

MR-1885-30/50/70/90W

SunFlowers blurs the lines between outdoor and indoor luminaires. A curb to cube family approach puts the focus on a variety of mounting options to cover a range of exterior and interior lighting needs. From roadways to pathways, public parks to university campuses, parking lots to lobbies, Sunflower has you covered. Mix and match lighting requirements with a consistent design aesthetic - outdoors and in.

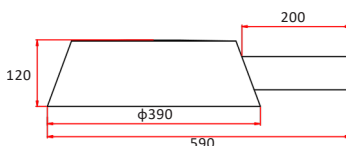

light source*	lumen output (lm)	lumin. efficacy (lm/w)	light beam options
5000°K white MR-1885-30W	4950.0	165.0	Type II
MR-1885-50W	8250.0		Type III
MR-1885-70W	11550.0		Type IV
MR-1885-90W	14850.0		Type V

3000/4000K CCT available on request

Finish color options :

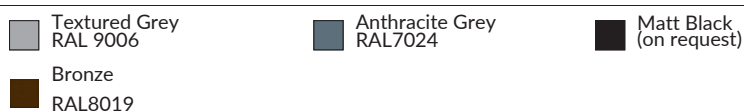

Customizable in different finishing colors

Option

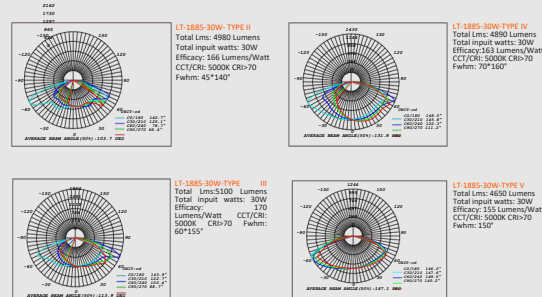



Technical data

Wattage	30/50/70/90W
IP Rating	IP65
IK Rating	IK08
Material	High corrosion resistance die-cast copper-free aluminum body
Coating	Polyester powder coating with phosphochromating pre-finish
Light source	SMD high-intensity power LEDs
Standard Deviation Color Matching	:MacAdam step 3
Screws	Stainless steel
Transformer	Electronic power supply 220/240V 50/60Hz built-in or AC120-277V
Gasket	Silicone rubber
Glass	Tempered
Power cable	1 mt. neoprene power cable included
Gross weight	7.3 Kg
Surge Protection	6 KV
Notes	Can on request DALI version available on request
Installation type	Catenary Mount



SUNFLOWER

MR-1885-30/50/70/90W

SunFlowers blurs the lines between outdoor and indoor luminaires. A curb to cube family approach puts the focus on a variety of mounting options to cover a range of exterior and interior lighting needs. From roadways to pathways, public parks to university campuses, parking lots to lobbies, Sunflower has you covered. Mix and match lighting requirements with a consistent design aesthetic - outdoors and in.

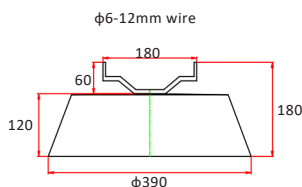

Option

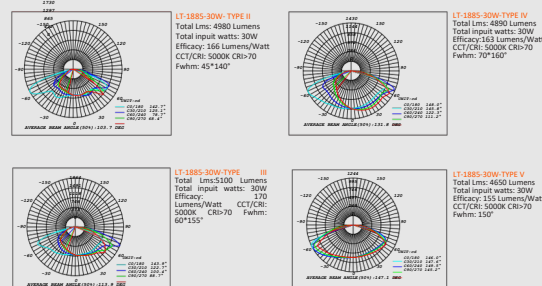

light source*	lumen output (lm)	lumin. efficacy (lm/w)	light beam options
5000°K white MR-1885-30W	4950.0	165.0	Type II
MR-1885-50W	8250.0		Type III
MR-1885-70W	11550.0		Type IV
MR-1885-90W	14850.0		Type V

3000/4000K CCT available on request

Finish color options :

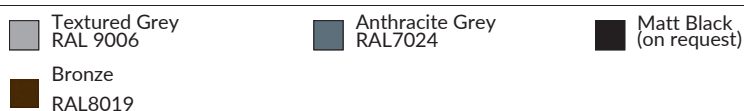

Customizable in different finishing colors





Technical data

Wattage	50/70/100W
IP Rating	IP66
IK Rating	IK08
Material	High corrosion resistance die-cast copper-free aluminum body
Coating	Polyester powder coating with phosphochromating pre-finish
Light source	SMD high-intensity power LEDs
Standard Deviation Color Matching	:MacAdam step 3
Screws	Stainless steel
Transformer	Electronic power supply 220/240V 50/60Hz built-in or AC120-277V
Gasket	Silicone rubber
Glass	Tempered
Power cable	1 mt. neoprene power cable included
Gross weight	7.3 Kg
Surge Protection	6 KV
Notes	Can on request DALI version available on request



PARASOL

MR-DZ-50/70/100W

Die-cast aluminium body (EN47100). Double layer polyester powder paint resistant to corrosion and salt spray fog. Silicone rubber gaskets. AISI 316 stainless steel external screws. Driver protected against voltage surges. PMMA lenses for LEDs. Screen made of 5mm thermal-shock resistant tempered glass.

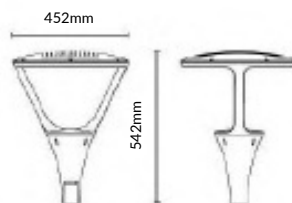

light source*	lumen output (lm)	lumin. efficacy (lm/w)	light beam options
5000°K white			
MR-OS-50W	6000.0	120.0	Type II
			Type III
MR-OS-70W	8400.0		Type IV
			Type IV Wide
MR-OS-100W	1200.0		Type V Square Medium
			Type V Wide (Round)

3000/4000K CCT available on request

Finish color options :

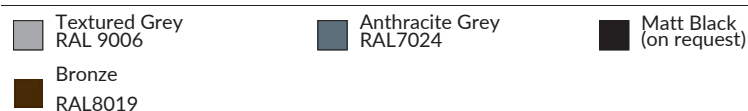

Customizable in different finishing colors

Option

ISOFOOT CANDLE PLOT (TYPE II)

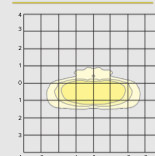

ISOFOOT CANDLE PLOT (TYPE III)

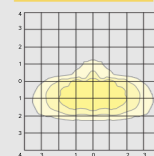

ISOFOOT CANDLE PLOT (TYPE IV)

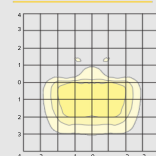

ISOFOOT CANDLE PLOT Type V Square Medium

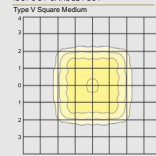

ISOFOOT CANDLE PLOT (Type Wide Round)

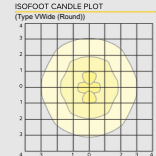



Technical data

Wattage	24W
IP Rating	IP65
IK Rating	IK08
Material	High corrosion resistance die-cast copper-free aluminum body +Aluminum profile
Coating	Polyester powder coating with phosphochromating pre-finish
Light source	8x5050LED CRI>80
Standard Deviation Color Matching :MacAdam step 3	
Screws	Stainless steel
Transformer	Electronic power supply 220/240V 50/60Hz built-in or AC120-277V/DC12-24V
Gasket	Silicone rubber
Glass	Tempered
Power Cables	Neoprene cable 3x0.75
Power cable	1 mt. neoprene power cable included
Lamp body material: Polycarbonate powder spraying on the surface of aluminum profile	

LAUGH

MR-BL-UT-24W

A series of LED light building elements with asymmetrical light distribution.
 Light building elements are luminous design features for public areas.
 They are ideally suited for delineating and structuring interior and exterior spaces such as landscape areas, plazas, building entrances

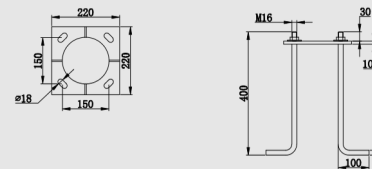

Concrete anchor 1024
 Material: steel
 *Need to be purchased separately

light source*	lumen output (lm)	lumin. efficacy (lm/w)	light beam options
5000K white			
MR-BL-UT-24W	1920.0	80.0	Asymmetric (70x150°)

3000/4000K CCT available on request

Unilateral light output

Finish color options :

- Textured Grey RAL 9006
- Anthracite Grey RAL7024
- Matt Black (on request)
- Bronze RAL8019

Customizable in different finishing colors





Technical data

Wattage	48W
IP Rating	IP65
IK Rating	IK08
Material	High corrosion resistance die-cast copper-free aluminum body +Aluminum profile
Coating	Polyester powder coating with phosphocromating pre-finish
Light source	16x5050LED CRI>80
Standard Deviation Color Matching	:MacAdam step 3
Screws	Stainless steel
Transformer	Electronic power supply 220/240V 50/60Hz built-in or AC120-277V/DC12-24V
Gasket	Silicone rubber
Glass	Tempered
Power Cables	Neoprene cable 3x0.75
Power cable	1 mt. neoprene power cable included
Lamp body material:	Polycarbonate powder spraying on the surface of aluminum profile

LAUGH

MR-BL-UT-48W

A series of LED light building elements with asymmetrical light distribution. Light building elements are luminous design features for public areas. They are ideally suited for delineating and structuring interior and exterior spaces such as landscape areas, plazas, building entrances

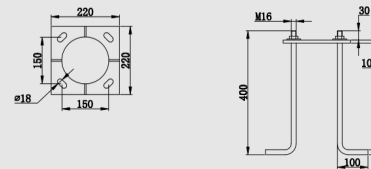
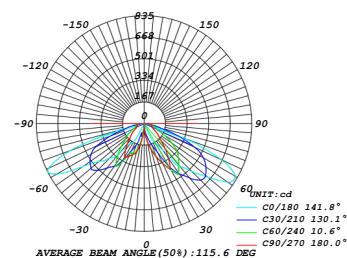

Concrete anchor 1024
 Material: steel
 *Need to be purchased separately

light source*	lumen output (lm)	lumin. efficacy (lm/w)	light beam options
5000K white			
MR-BL-UT-48W	3840.0	80.0	Asymmetric 2*(70x150°)

3000/4000K CCT available on request Unilateral light output

Finish color options :

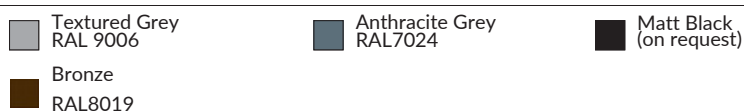

Customizable in different finishing colors





Technical data

Wattage	36W
IP Rating	IP65
IK Rating	IK08
Material	High corrosion resistance die-cast copper-free aluminum body +Aluminum profile
Coating	Polyester powder coating with phosphochromating pre-finish
Light source	12x5050LED CRI>80
Standard Deviation Color Matching	:MacAdam step 3
Screws	Stainless steel
Transformer	Electronic power supply 220/240V 50/60Hz built-in or AC120-277V/DC12-24V
Gasket	Silicone rubber
Glass	Tempered
Power cable	1 mt. neoprene power cable included

Lamp body material: Polycarbonate powder spraying on the surface of aluminum profile

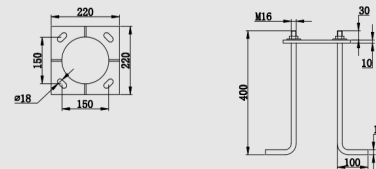

Concrete anchor 1024
Material: steel
*Need to be purchased separately



LAUGH

MR-BL-UT-36W

A series of LED light building elements with asymmetrical light distribution. Light building elements are luminous design features for public areas. They are ideally suited for delineating and structuring interior and exterior spaces such as landscape areas, plazas, building entrances

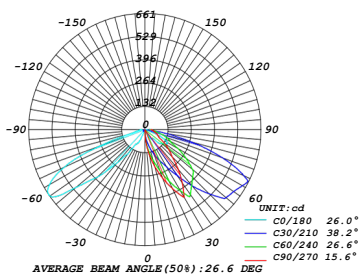

light source*	lumen output (lm)	lumin. efficacy (lm/w)	light beam options
5000K white			
MR-BL-UT-36W	2880.0	80.0	Asymmetric (70x150°)

3000/4000K CCT available on request Unilateral light output

Finish color options :

- Textured Grey
RAL 9006
- Anthracite Grey
RAL7024
- Matt Black
(on request)
- Bronze
RAL8019

Customizable in different finishing colors





Technical data

Wattage	72W
IP Rating	IP65
IK Rating	IK08
Material	High corrosion resistance die-cast copper-free aluminum body +Aluminum profile
Coating	Polyester powder coating with phosphocromating pre-finish
Light source	24x5050LED CRI>80
Standard Deviation Color Matching	:MacAdam step 3
Screws	Stainless steel
Transformer	Electronic power supply 220/240V 50/60Hz built-in or AC120-277V/DC12-24V
Gasket	Silicone rubber
Glass	Tempered
Power cable	1 mt. neoprene power cable included

Lamp body material: Polycarbonate powder spraying on the surface of aluminum profile



LAUGH

MR-BL-UT-72W

A series of LED light building elements with asymmetrical light distribution. Light building elements are luminous design features for public areas. They are ideally suited for delineating and structuring interior and exterior spaces such as landscape areas, plazas, building entrances

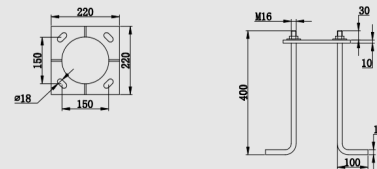
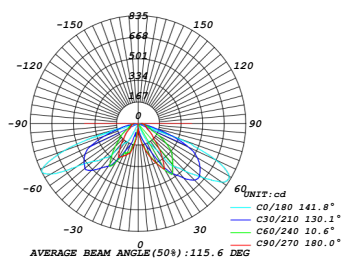

Concrete anchor 1024
Material: steel
*Need to be purchased separately

light source*	lumen output (lm)	lumin. efficacy (lm/w)	light beam options
5000K white			
RM-BL-UT-72W	5760.0	80.0	Asymmetric 2*(70x150°)

3000/4000K CCT available on request

Unilateral light output

Finish color options :

- Textured Grey RAL 9006
- Anthracite Grey RAL7024
- Matt Black (on request)
- Bronze RAL8019

Customizable in different finishing colors



WALL MOUNTING

Mora®
Professional Lighting





Technical data

Wattage	5/20/30W
IP Rating	IP65
IK Rating	IK06
Material	High corrosion resistance die-cast copper-free aluminum body +Acrylic
Coating	Polyester powder coating with phosphochromating pre-finish
Light source	High-Brightness LED CRI>80
Standard Deviation Color Matching	:MacAdam step 3
Screws	Stainless steel
Transformer	Electronic power supply 120-277V 50/60Hz built-in
Gasket	Silicone rubber
Glass	Tempered
Power Cables	Internal wiring
Gross weight	1 Kg



POPLAR

MR-BY

The Poplar outdoor wall sconce creates an elegant elongated column of beautifully diffused light. The Poplar is available in three sizes (20cm,40cm,60cm) to meet architectural scale; ideal for way-finding and general outdoor illumination. The Poplar features energy-efficient, fully dimmable integrated LED lamping(Dimming options). Available in two finishes: Bronze and Oak grain.

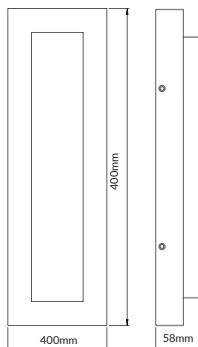

Option

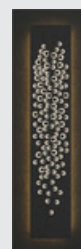

Grape

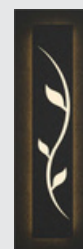

Willow

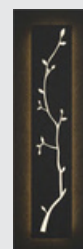

Plum

light source*	lumen output (lm)	lumin. efficacy (lm/w)	light beam options
5000K white RM-BY-5W			
	150.0	30.0	Asymmetric
RM-BY-20W	600.0		
RM-BY-30W	900.0		

3000/4000K CCT available on request

Finish color options :

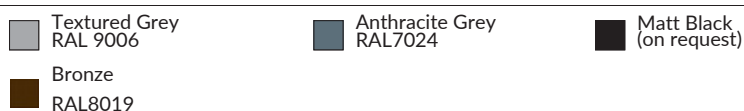

Customizable in different finishing colors

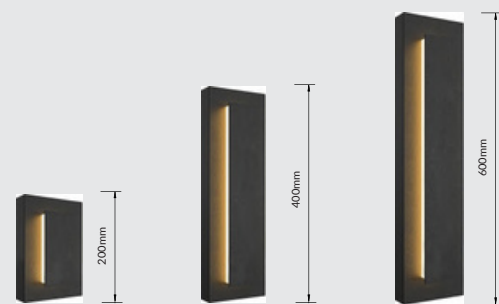



Technical data

Wattage	20W
IP Rating	IP65
IK Rating	IK06
Material	High corrosion resistance die-cast copper-free aluminum body +Aluminum profile
Coating	Polyester powder coating with phosphochromating pre-finish
Light source	High-Brightness LED CRI>80
Standard Deviation Color Matching	:MacAdam step 3
Screws	Stainless steel
Transformer	Electronic power supply 120-277V 50/60Hz built-in
Gasket	Silicone rubber
Glass	Tempered
Power Cables	Internal wiring
Gross weight	1 Kg

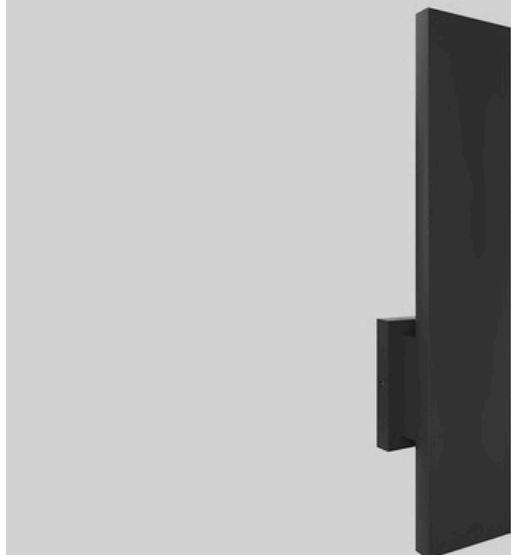

BLADE

MR-WW-18

The contemporary aesthetic of the LT-WW-18 outdoor wall sconce creates soft indirect, reduced-glare illumination by aiming light back against the wall for accenting architecture as well as for wayfinding.

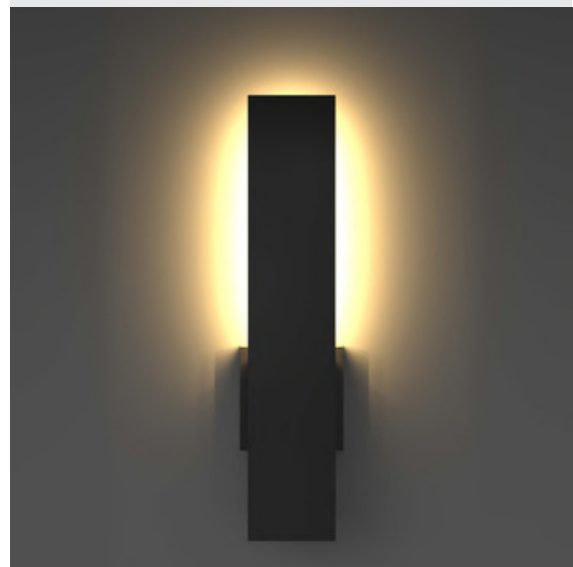
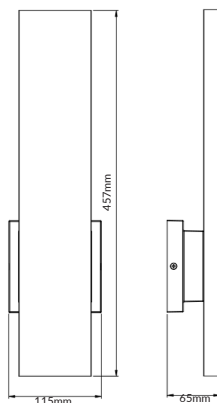

light source*	lumen output (lm)	lumin. efficacy (lm/w)	light beam options
5000K white			
RM-WW-18-20W	1200.0	60.0	Asymmetric

3000/4000K CCT available on request

Finish color options :

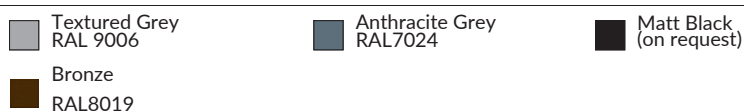

Customizable in different finishing colors

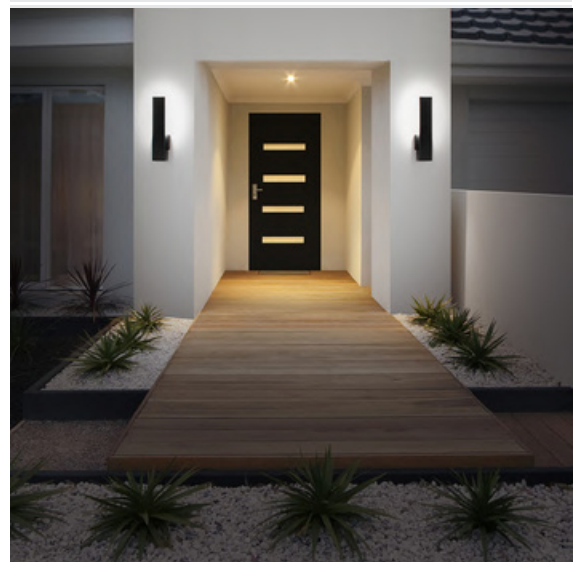



Technical data

Wattage	12W
IP Rating	IP65
IK Rating	IK06
Material	High corrosion resistance die-cast copper-free aluminum body +Aluminum profile
Coating	Polyester powder coating with phosphochromating pre-finish
Light source	High-Brightness LED CRI>80
Standard Deviation Color Matching	:MacAdam step 3
Screws	Stainless steel
Transformer	Electronic power supply 220-240V or 120-277V 50/60Hz built-in
Gasket	Silicone rubber
Glass	Tempered
Power Cables	Internal wiring
Gross weight	1 Kg

BLADE

MR-CL

Strikingly elegant in its simplicity, LT-CL is a tubular design that creates a modern industrial look. Designed with a die-cast aluminum structure, powder coat finish, and stainless steel hardware for robust durability in harsh elements. Appropriate for commercial use. Available as Square or Round in three sizes.

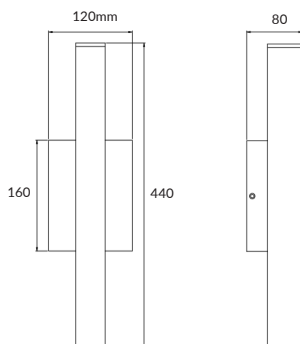

Total Lumen Output:	1286
Total Power:	11.8
Luminaire Efficacy:	109
Color Temp:	B3010-0K
CRI:	80+
BUG Rating:	

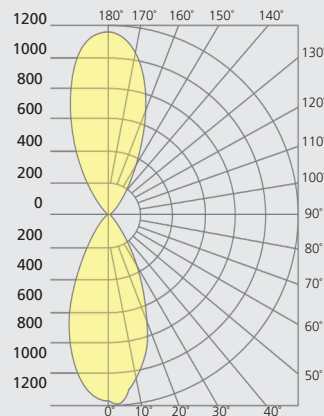

light source*	lumen output (lm)	lumin. efficacy (lm/w)	light beam options
5000K white			
RM-CL-12W	1286.0	100.0	15° 24° 36°

3000/4000K CCT available on request

Finish color options :

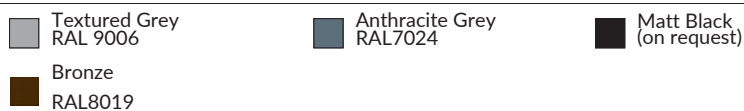

Customizable in different finishing colors





Technical data

Wattage	12W
IP Rating	IP65
IK Rating	IK06
Material	High corrosion resistance die-cast copper-free aluminum body +Aluminum profile
Coating	Polyester powder coating with phosphochromating pre-finish
Light source	High-Brightness LED CRI>80
Standard Deviation Color Matching	:MacAdam step 3
Screws	Stainless steel
Transformer	Electronic power supply 220-240V or 120-277V 50/60Hz built-in
Gasket	Silicone rubber
Glass	Tempered
Power Cables	Internal wiring
Gross weight	1 Kg

BLADE

MR-CL

Strikingly elegant in its simplicity, LT-CL is a tubular design that creates a modern industrial look. Designed with a die-cast aluminum structure, powder coat finish, and stainless steel hardware for robust durability in harsh elements. Appropriate for commercial use. Available as Square or Round in three sizes.

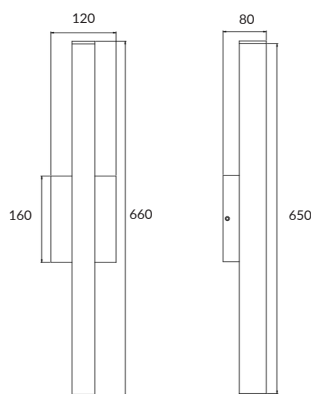

Total Lumen Output:	1286
Total Power:	11.8
Luminaire Efficacy:	109
Color Temp:	3000K
CRI:	80+
BUG Rating:	B1-U4-G0

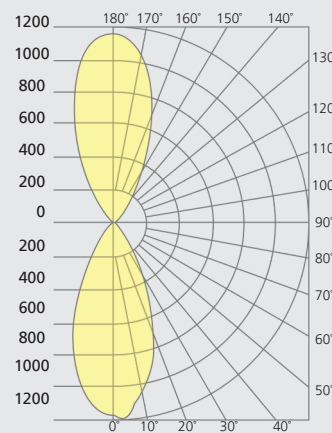

light source*	lumen output (lm)	lumin. efficacy (lm/w)	light beam options
5000K white			
RM-CL-12W	1286.0	100.0	15° 24° 36°

3000/4000K CCT available on request

Finish color options :

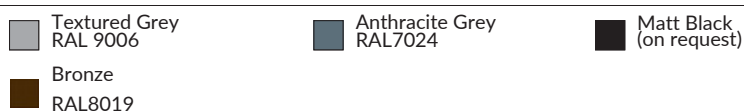

Customizable in different finishing colors

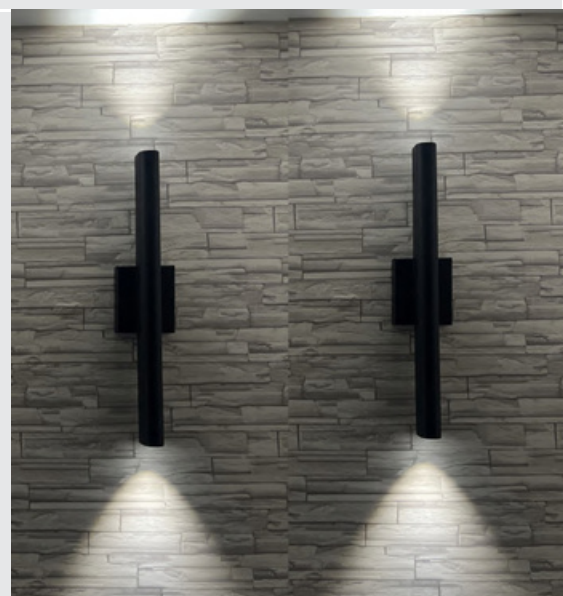



Technical data

Wattage	12W
IP Rating	IP65
IK Rating	IK06
Material	High corrosion resistance die-cast copper-free aluminum body +Aluminum profile
Coating	Polyester powder coating with phosphochromating pre-finish
Light source	High-Brightness LED CRI>80
Standard Deviation Color Matching	:MacAdam step 3
Screws	Stainless steel
Transformer	Electronic power supply 220-240V or 120-277V 50/60Hz built-in
Gasket	Silicone rubber
Glass	Tempered
Power Cables	Internal wiring
Gross weight	1 Kg



BLADE

MR-WL

Strikingly elegant in its simplicity, LT-CL is a tubular design that creates a modern industrial look. Designed with a die-cast aluminum structure, powder coat finish, and stainless steel hardware for robust durability in harsh elements. Appropriate for commercial use. Available as Square or Round in three sizes.

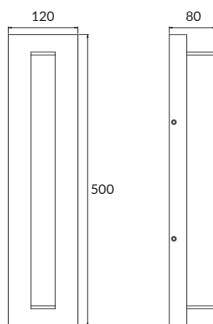

Total Lumen Output:	1286
Total Power:	11.8
Luminaire Efficacy:	109
Color Temp:	3000K
CRI:	80+
BUG Rating:	B1-U4-G0

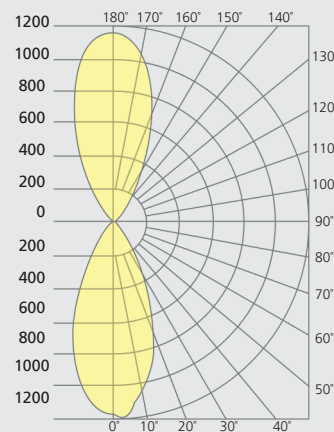

light source*	lumen output (lm)	lumin. efficacy (lm/w)	light beam options
5000K white			
RM-WL-12W	1286.0	100.0	15° 24° 36°

3000/4000K CCT available on request

Finish color options :

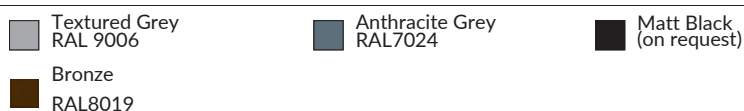

Customizable in different finishing colors





Technical data

Wattage	15/20/25W
IP Rating	IP65
IK Rating	IK06
Material	High corrosion resistance die-cast copper-free aluminum body
Coating	Polyester powder coating with phosphochromating pre-finish
Light source	1x COB CRI>80
Standard Deviation Color Matching	:MacAdam step 3
Screws	Stainless steel
Transformer	Electronic power supply 120-277V 50/60Hz built-in
Gasket	Silicone rubber
Glass	Reflective cup
Power Cables	Internal wiring
Gross weight	1.2 Kg



MR-XT-06

Heavy duty die-cast aluminum housing and door. The door frame is fully gasketed to keep out moisture and dust for the luminaire. Specular thermoplastic reflector and clear glass lens. Integral secondary heat sink to optimize thermal transfer and maximize performance and life of LED. Driver is mounted in direct contact with the casting for a low operating temperature and long life.

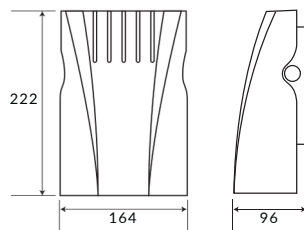

INTENSITY DISTRIBUTION DIAGRAM IN C PLANS

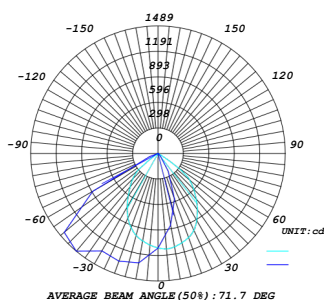

Option



Extra swivel photocell sensor available

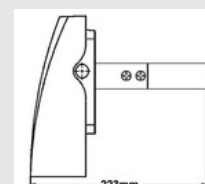

Stainless steel U-shaped bracket

light source*	lumen output (lm)	lumin. efficacy (lm/w)	light beam options
5000K white RM-XT-06-15W	1500.0	100.0	Asymmetric
RM-XT-06-20W	2000.0		
RM-XT-06-25W	2500.0		

3000/4000K CCT available on request

Finish color options :

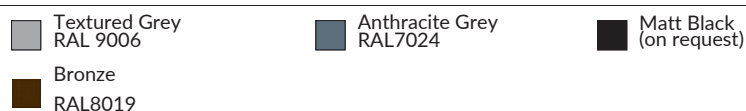

Customizable in different finishing colors



RECESSED

FOR OUTDOOR APPLICATIONS





Technical data

Wattage	5W
IP Rating	IP66
IK Rating	IK08
Material	316 stainless steel
Coating	Stainless steel natural color
Light source	High-Brightness LED CRI>80
Standard Deviation Color Matching	:MacAdam step 3
Screws	Stainless steel
Transformer	DC24V
Glass	5mm tempered glass
Power cable	1 mt. neoprene power cable included
Gross weight	1 Kg

MR-BM-316

Vandalresistant polycarbonatemolded housingcover and lens,maximize performanceandlife of LED Driveris mounted in direct contact with the chamber for a low operating temperature and long life Polyester powder-coated finish, rust and corrosion proof, stabilized to extreme climate changes without cracking or peeling.

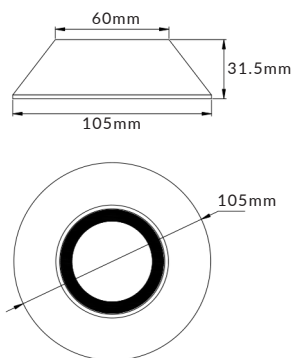

Option

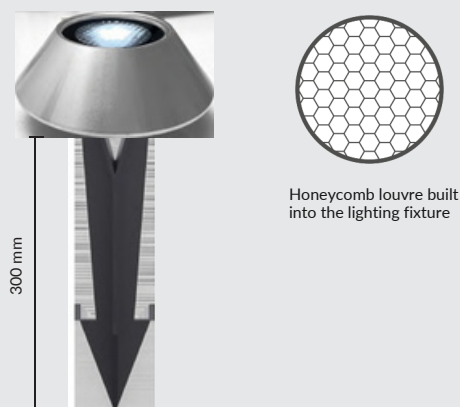

Surface mount base

light source*	lumen output (lm)	lumin. efficacy (lm/w)	light beam options
5000K white			
RM-BM-316-5W	450.0	90.0	8/11/15/30/45 /66/40*12°

3000/4000K CCT available on request

Light distribution options:

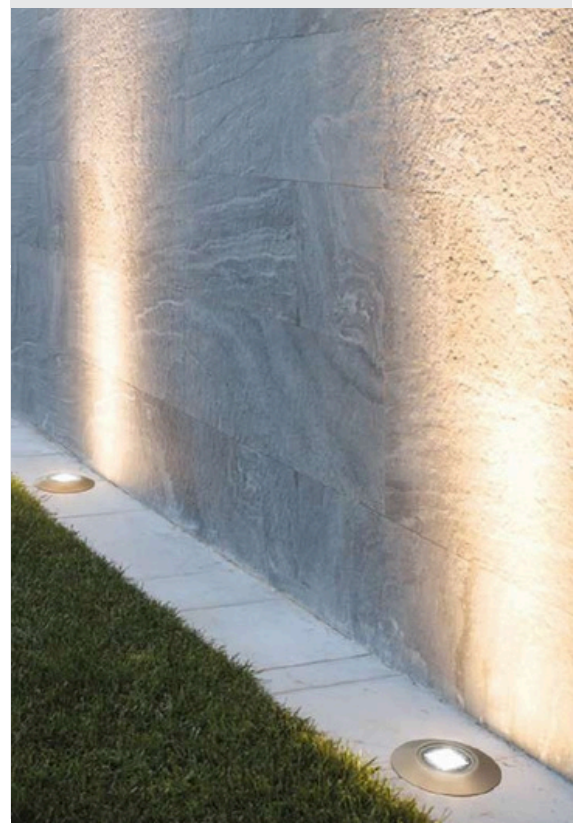
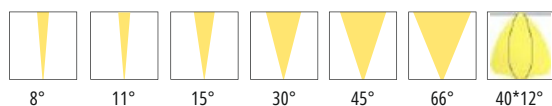

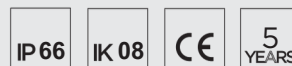

Technical data

Wattage	6W
IP Rating	IP66
IK Rating	IK08
Material	304 stainless steel
Coating	Stainless steel natural color
Light source	High-Brightness LED CRI>80
Standard Deviation Color Matching	:MacAdam step 3
Screws	Stainless steel
Transformer	AC220-240V
Glass	5mm tempered glass
Power cable	1 mt. neoprene power cable included
Dimension	φ120mm
Gross weight	1.1 Kg



MR-DMD-130-6W

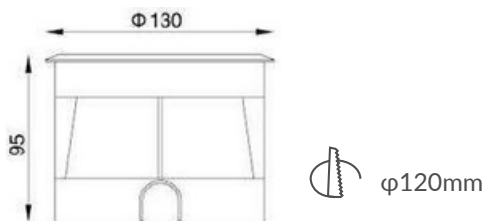
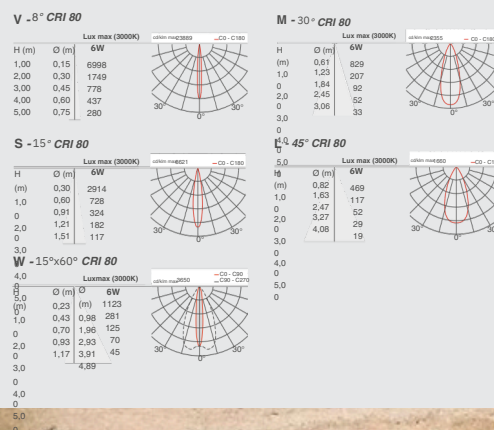

light source*	lumen output (lm)	lumin. efficacy (lm/w)	light beam options
5000K white			
RM-DMD-130-6W	540.0	90.0	8/15/30/45 /15*60°

3000/4000K CCT available on request

Light distribution options:

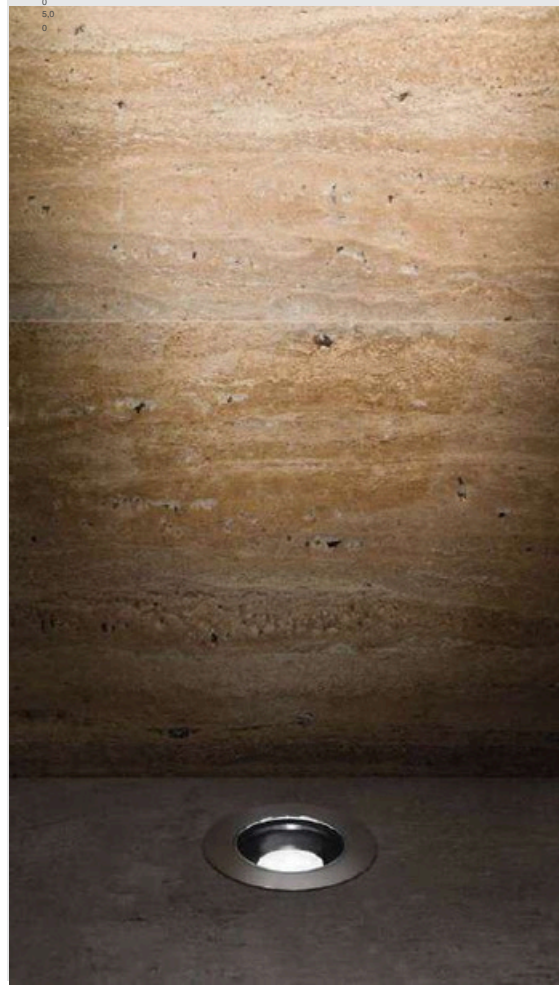
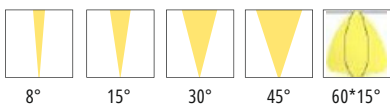



Technical data

Wattage	9W
IP Rating	IP66
IK Rating	IK08
Material	304 stainless steel
Coating	Stainless steel natural color
Light source	High-Brightness LED CRI>80
Standard Deviation Color Matching	:MacAdam step 3
Screws	Stainless steel
Transformer	AC220-240V
Glass	5mm tempered glass
Power cable	1 mt. neoprene power cable included
Dimension	φ145mm
Gross weight	1.8 Kg



MR-DMD-160-9W

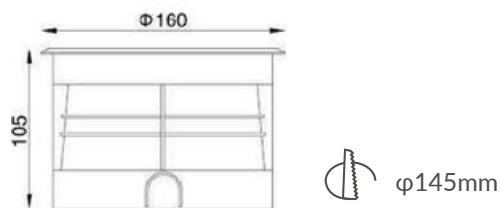
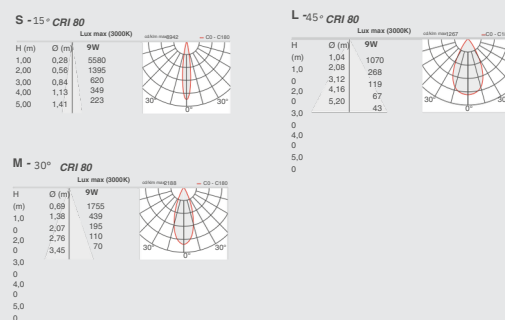

light source*	lumen output (lm)	lumin. efficacy (lm/w)	light beam options
5000K white			
RM-DMD-160-9W	810.0	90.0	8/15/30/45 /15*60°

3000/4000K CCT available on request

Light distribution options:

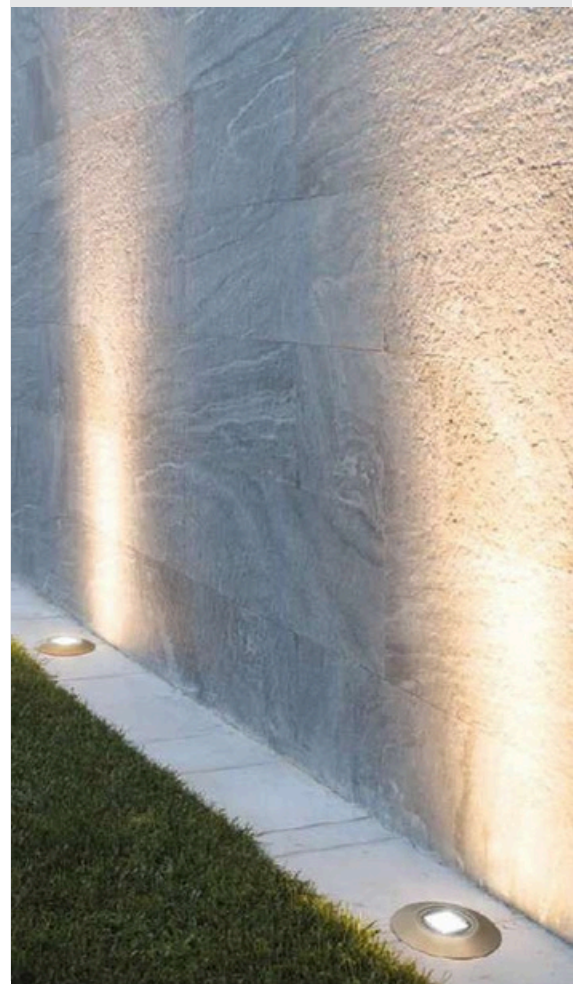
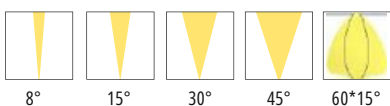



Technical data

Wattage	18W
IP Rating	IP66
IK Rating	IK08
Material	304 stainless steel
Coating	Stainless steel natural color
Light source	High-Brightness LED CRI>80
Standard Deviation Color Matching	:MacAdam step 3
Screws	Stainless steel
Transformer	AC220-240V
Glass	5mm tempered glass
Power cable	1 mt. neoprene power cable included
Dimension	φ215mm
Gross weight	3.3 Kg



MR-DMD-230-18W

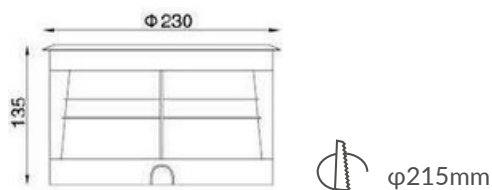
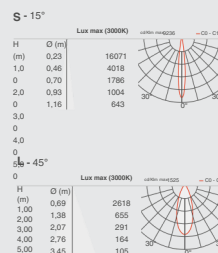

light source*	lumen output (lm)	lumin. efficacy (lm/w)	light beam options
5000K white			
RM-DMD-230-18W	1620.0	90.0	8/15/30/45 /15*60°

3000/4000K CCT available on request

Light distribution options:

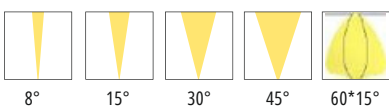

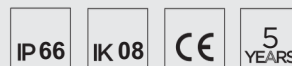

Technical data

Wattage	24W
IP Rating	IP66
IK Rating	IK08
Material	304 stainless steel
Coating	Stainless steel natural color
Light source	High-Brightness LED CRI>80
Standard Deviation Color Matching	:MacAdam step 3
Screws	Stainless steel
Transformer	AC 220-240V
Glass	5mm tempered glass
Power cable	1 mt. neoprene power cable included
Dimension	φ240mm
Gross weight	4.2 Kg



MR-DMD-260-24W

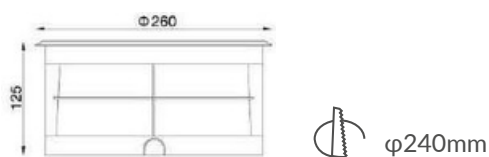
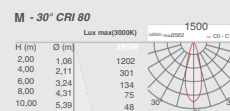

light source*	lumen output (lm)	lumin. efficacy (lm/w)	light beam options
5000K white			
RM-DMD-230-24W	2160.0	90.0	8/15/30/45 /15°*60°

3000/4000K CCT available on request

Light distribution options:

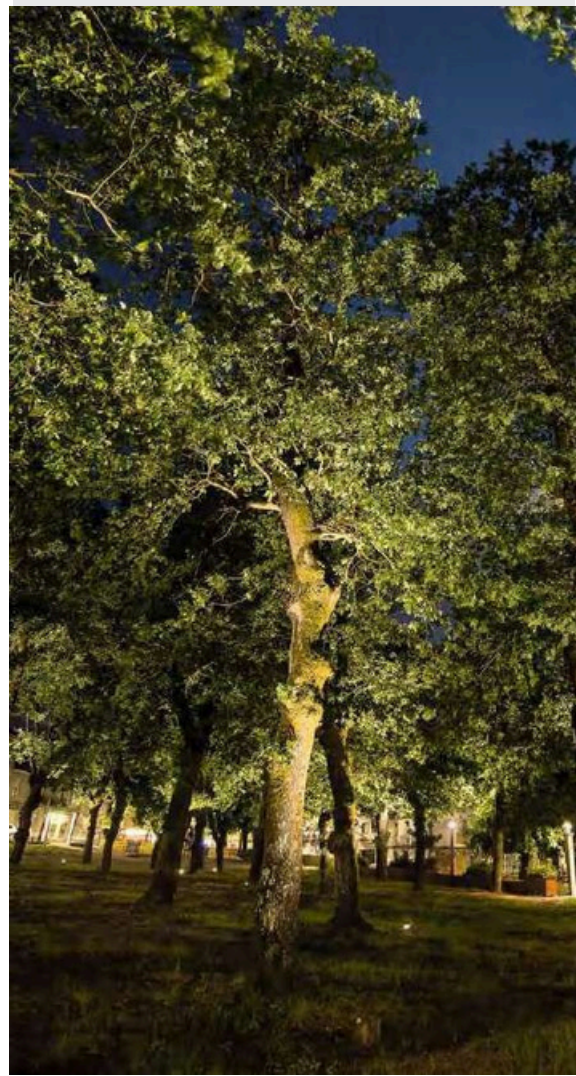
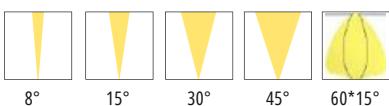



Technical data

Wattage	8W
IP Rating	IP66
IK Rating	IK08
Material	304 stainless steel
Coating	Stainless steel natural color
Light source	1 x COB CRI>80
Standard Deviation Color Matching	:MacAdam step 3
Screws	Stainless steel
Transformer	AC220-240V
Glass	5mm tempered glass
Power cable	1 mt. neoprene power cable included
Dimension	φ90mm
Gross weight	1Kg



MR-DMD-100-8W

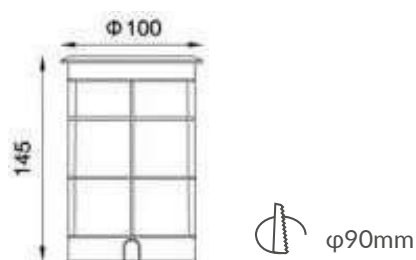
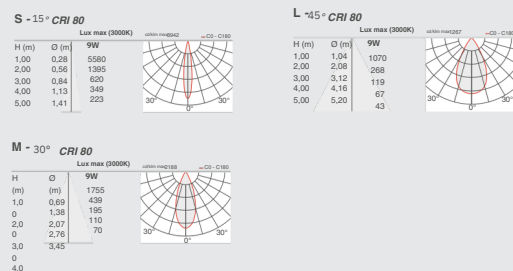

light source*	lumen output (lm)	lumin. efficacy (lm/w)	light beam options
5000K white			
RM-DMD-160-8W	780.0	90.0	15/24/45/60°

3000/4000K CCT available on request

Light distribution options:

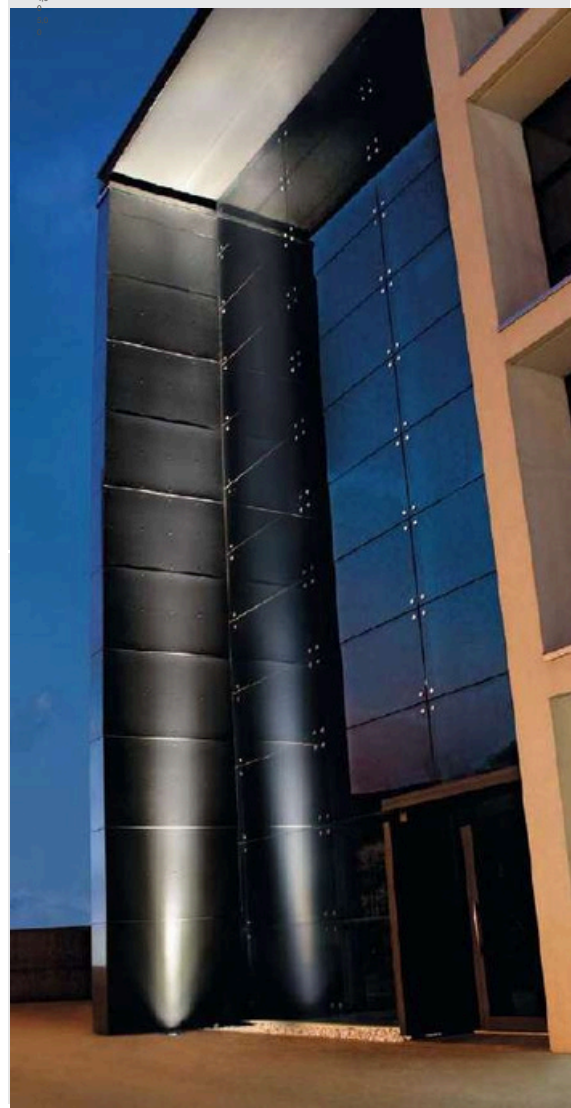
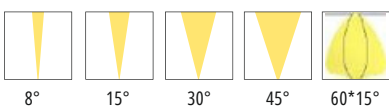



Technical data

Wattage	7W
IP Rating	IP66
IK Rating	IK08
Material	304 stainless steel
Coating	Stainless steel natural color
Light source	1 x COB CRI>80
Standard Deviation Color Matching	:MacAdam step 3
Screws	Stainless steel
Transformer	AC220-240V
Glass	5mm tempered glass
Power cable	1 mt. neoprene power cable included
Dimension	φ105mm
Gross weight	1 Kg



MR-DMD-120-7W

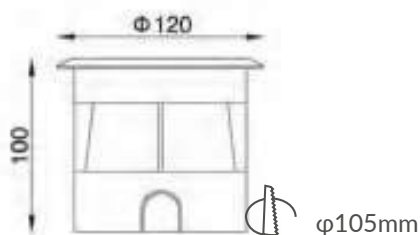

light source*	lumen output (lm)	lumin. efficacy (lm/w)	light beam options
5000K white			
RM-DMD-120-7W	630.0	90.0	15/24/45/60°

3000/4000K CCT available on request

Light distribution options:

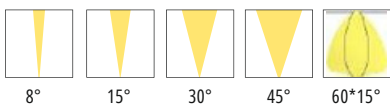

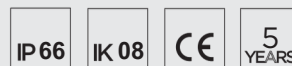

Technical data

Wattage	15W
IP Rating	IP66
IK Rating	IK08
Material	304 stainless steel
Coating	Stainless steel natural color
Light source	1 x COB CRI>80
Standard Deviation Color Matching	:MacAdam step 3
Screws	Stainless steel
Transformer	AC220-240V
Glass	5mm tempered glass
Power cable	1 mt. neoprene power cable included
Dimension	φ170mm
Gross weight	2Kg



MR-DMD-180-15W

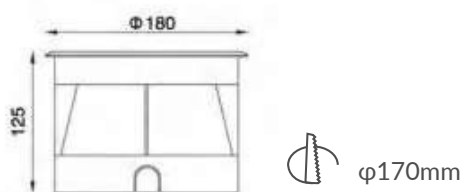

light source*	lumen output (lm)	lumin. efficacy (lm/w)	light beam options
5000K white			
RM-DMD-180-15W	1350.0	90.0	15/24/45/60°

3000/4000K CCT available on request

Light distribution options:

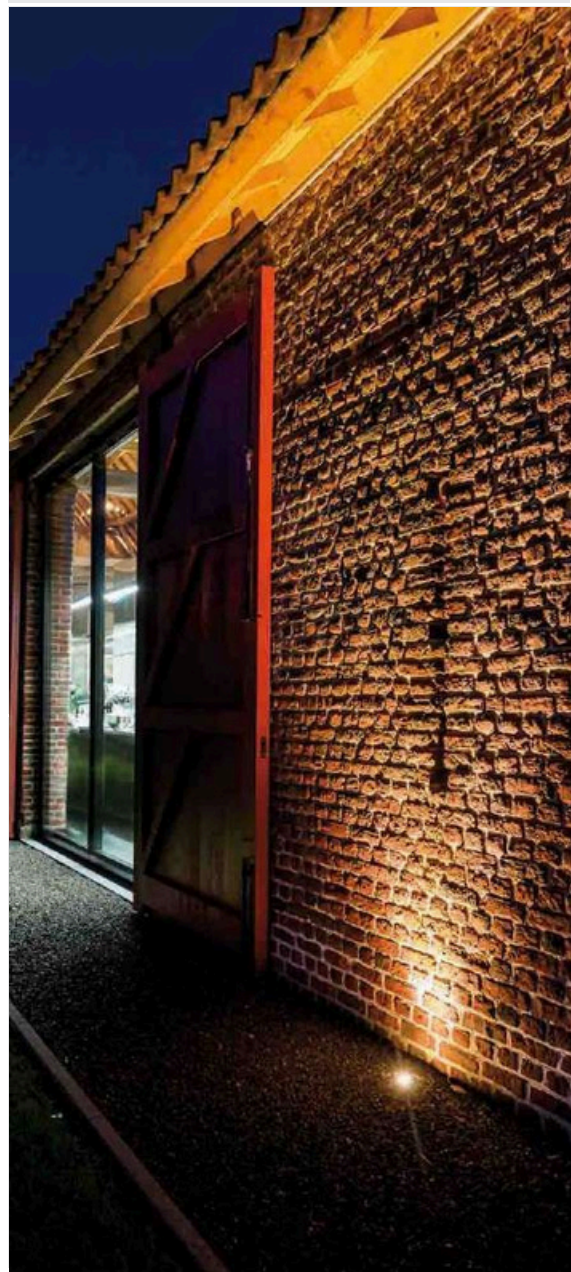
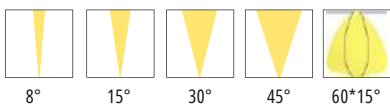

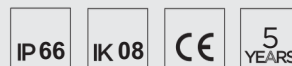

Technical data

Wattage	10W
IP Rating	IP66
IK Rating	IK08
Material	304 stainless steel
Coating	Stainless steel natural color
Light source	1 x COB CRI>80
Standard Deviation Color Matching	:MacAdam step 3
Screws	Stainless steel
Transformer	AC220-240V
Glass	5mm tempered glass
Power cable	1 mt. neoprene power cable included
Dimension	φ135mm
Gross weight	1.5Kg



MR-DMD-150-10W

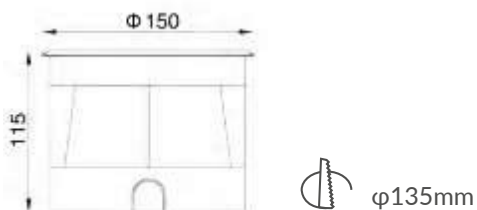

light source*	lumen output (lm)	lumin. efficacy (lm/w)	light beam options
5000K white			
RM-DMD-150-10W	900.0	90.0	15/24/45/60°

3000/4000K CCT available on request

Light distribution options:

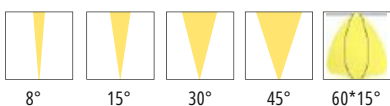

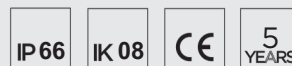

Technical data

Wattage	30W
IP Rating	IP66
IK Rating	IK08
Material	304 stainless steel
Coating	Stainless steel natural color
Light source	1 x COB CRI>80
Standard Deviation Color Matching	:MacAdam step 3
Screws	Stainless steel
Transformer	AC220-240V
Glass	5mm tempered glass
Power cable	1 mt. neoprene power cable included
Dimension	φ245mm
Gross weight	4.2Kg



MR-DMD-260-30W

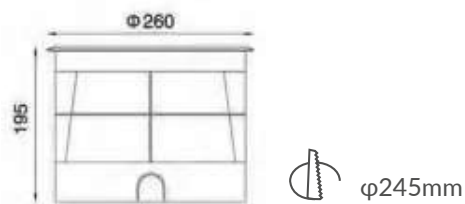

light source*	lumen output (lm)	lumin. efficacy (lm/w)	light beam options
5000K white			
RM-DMD-260-30W	2700.0	90.0	15/24/45/60°

3000/4000K CCT available on request

Light distribution options:

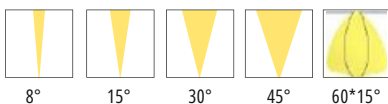

STREET LAMP

Mora[®]
Professional Lighting





Technical data

Wattage	100/150/200W
IP Rating	IP65
IK Rating	IK06
Material	High corrosion resistance die-cast copper-free aluminum body
Coating	Polyester powder coating with phosphochromating pre-finish
Light source	144/200/288 x 3030LED CRI>70
Standard Deviation Color Matching	:MacAdam step 3
Screws	Stainless steel
Transformer	Electronic power supply 220/240V 50/60Hz built-in or AC120-277V
Gasket	Silicone rubber
Glass	Tempered
Power Cables	Neoprene cable 3x0.75
Gross weight	5.5 Kg
Surge Protection	6 KV

L TOK

MR-OK-100/150/200W

The L TOK LED area/site luminaire delivers exceptional performance in a scalable, low-profile design. The precision engineered optics provide uniform illumination to walkways, parking lots, roadways, building areas and security lighting applications. Backed by a five-year limited warranty, the L TOK LED area/site luminaire is the LED answer to your area and site lighting needs.

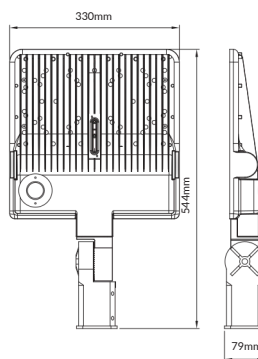

light source*	lumen output (lm)	lumin. efficacy (lm/w)	light beam options
5000°K white RM-OK-100W	14000.0	140.0	TYPE II 45°x155°
RM-OK-150W			TYPE V 135°
RM-OK-200W	28000.0		Asymmetric TYPE III(73x149°) Asymmetric TYPE IV(86x153°)

3000/4000K CCT available on request

Finish color options :

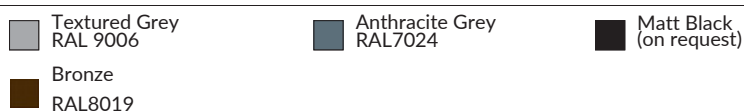

Customizable in different finishing colors

Option

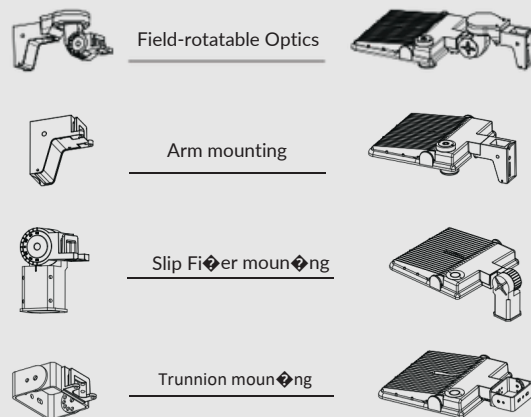

Photocell





Technical data

Wattage	300W
IP Rating	IP65
IK Rating	IK06
Material	High corrosion resistance die-cast copper-free aluminium body
Coating	Polyester powder coating with phosphochromating pre-finish
Light source	464 x 3030LED CRI>70
Standard Deviation Color Matching	:MacAdam step 3
Screws	Stainless steel
Transformer	Electronic power supply 220/240V 50/60Hz built-in or AC120-277V
Gasket	Silicone rubber
Glass	Tempered
Power cable	1 mt. neoprene power cable included
Gross weight	8.4Kg
Surge Protection	6 KV

L TOK

MR-OK-300W

The L TOK LED area/site luminaire delivers exceptional performance in a scalable, low-profile design. The precision engineered optics provide uniform illumination to walkways, parking lots, roadways, building areas and security lighting applications. Backed by a five-year limited warranty, the L TOK LED area/site luminaire is the LED answer to your area and site lighting needs.

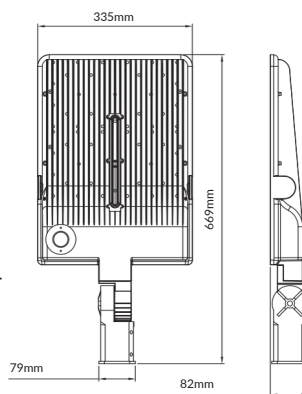

light source*	lumen output (lm)	lumin. efficacy (lm/w)	light beam options
5000°K white			TYPE II 45°x155°
RM-OK-300W	42000.0	140.0	TYPE V 135°
			Asymmetric TYPE III(73x149°)
			Asymmetric TYPE IV(86x153°)

3000/4000K CCT available on request

Finish color options :

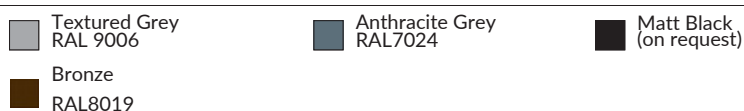

Customizable in different finishing colors

Option

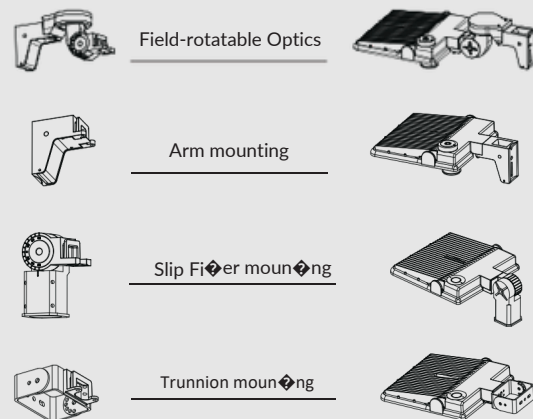

Photocell

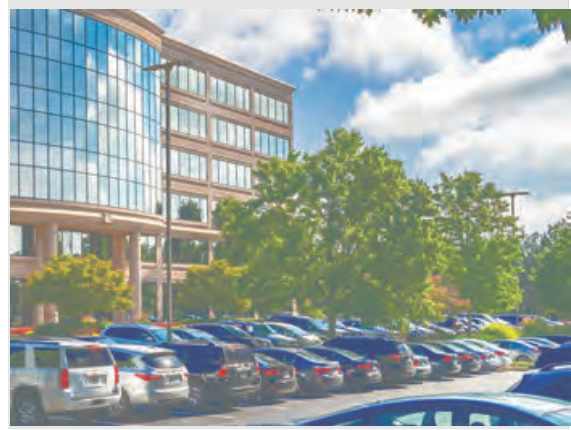



Technical data

Wattage	50/70W
IP Rating	IP65
IK Rating	IK08
Material	High corrosion resistance die-cast copper-free aluminum body
Coating	Polyester powder coating with phosphochromating pre-finish
Light source	SMD high-intensity power LEDs
Standard Deviation Color Matching	:MacAdam step 3
Screws	Stainless steel
Transformer	Electronic power supply 220/240V 50/60Hz built-in or AC120-277V
Gasket	Silicone rubber
Glass	Tempered
Power cable	1 mt. neoprene power cable included
Gross weight	3.8 Kg
Surge Protection	6 KV/10KV
Notes	Can on request DALI version available on request



MR-OS-50/70W

Die-cast aluminium body (EN47100).
 Double layer polyester powder paint resistant to corrosion and salt spray fog.
 Silicone rubber gaskets.
 AISI 316 stainless steel external screws.
 Driver protected against voltage surges up to 10kV.
 PMMA lenses for LEDs.
 Screen made of 5mm thermal-shock resistant tempered glass.
 High quality LED sources characterized according to IES TM-30, with high color consistency <3SDCM and long useful life >60000 hours at L80.

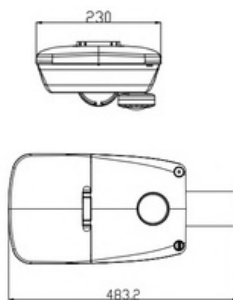

Option



Photocell



light source*	lumen output (lm)	lumin. efficacy (lm/w)	light beam options
5000°K white			
RM-OS-50W	6500.0	130.0	Type II
			Type III
			Type IV
RM-OS-70W	9100.0		Type IV Wide
			Type V Square Medium
			Type V Wide (Round)

3000/4000K CCT available on request

Finish color options :

- Textured Grey RAL 9006
- Anthracite Grey RAL7024
- Matt Black (on request)
- Bronze RAL8019

Customizable in different finishing colors

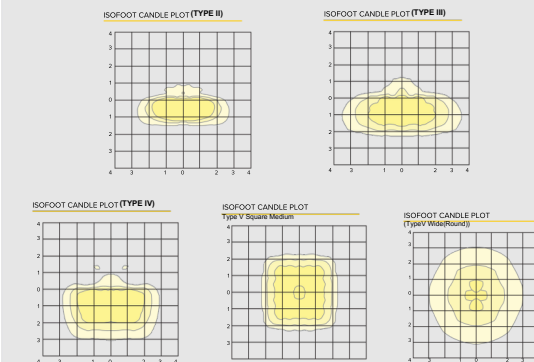



Technical data

Wattage	100W
IP Rating	IP65
IK Rating	IK08
Material	High corrosion resistance die-cast copper-free aluminum body
Coating	Polyester powder coating with phosphochromating pre-finish
Light source	SMD high-intensity power LEDs
Standard Deviation Color Matching	:MacAdam step 3
Screws	Stainless steel
Transformer	Electronic power supply 220/240V 50/60Hz built-in or AC120-277V
Gasket	Silicone rubber
Glass	Tempered
Power cable	1 mt. neoprene power cable included
Gross weight	4.2 Kg
Surge Protection	6 KV/10KV
Notes	Can on request DALI version available on request



MR-OS-100W

Die-cast aluminium body (EN47100).
 Double layer polyester powder paint resistant to corrosion and salt spray fog.
 Silicone rubber gaskets.
 AISI 316 stainless steel external screws.
 Driver protected against voltage surges up to 10kV.
 PMMA lenses for LEDs.
 Screen made of 5mm thermal-shock resistant tempered glass.
 High quality LED sources characterized according to IES TM-30, with high color consistency <3SDCM and long useful life >60000 hours at L80.

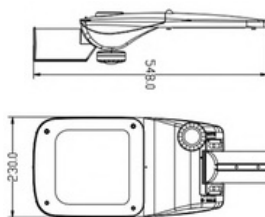

light source*	lumen output (lm)	lumin. efficacy (lm/w)	light beam options
5000°K white			Type II
			Type III
			Type IV
			Type IV Wide
			Type V Square Medium
			Type V Wide (Round)

3000/4000K CCT available on request

Finish color options :

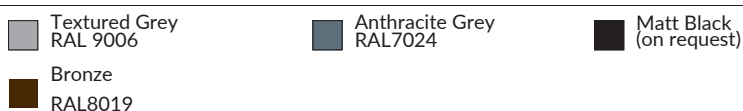

Customizable in different finishing colors

Option



Photocell

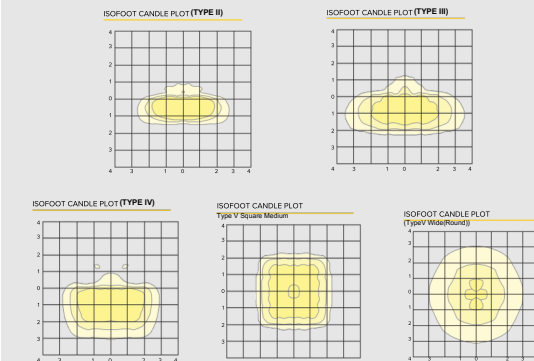



Technical data

Wattage	150W
IP Rating	IP65
IK Rating	IK08
Material	High corrosion resistance die-cast copper-free aluminum body
Coating	Polyester powder coating with phosphochromating pre-finish
Light source	SMD high-intensity power LEDs
Standard Deviation Color Matching	:MacAdam step 3
Screws	Stainless steel
Transformer	Electronic power supply 220/240V 50/60Hz built-in or AC120-277V
Gasket	Silicone rubber
Glass	Tempered
Power cable	1 mt. neoprene power cable included
Gross weight	5.5 Kg
Surge Protection	6 KV/10KV
Notes	Can on request DALI version available on request



MR-OS-150W

Die-cast aluminium body (EN47100).
 Double layer polyester powder paint resistant to corrosion and salt spray fog.
 Silicone rubber gaskets.
 AISI 316 stainless steel external screws.
 Driver protected against voltage surges up to 10kV.
 PMMA lenses for LEDs.
 Screen made of 5mm thermal-shock resistant tempered glass.
 High quality LED sources characterized according to IES TM-30, with high color consistency <3SDCM and long useful life >60000 hours at L80.

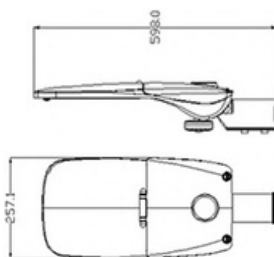

light source*	lumen output (lm)	lumin. efficacy (lm/w)	light beam options
5000°K white			Type II
			Type III
RM-OS-150W	19500.0	130.0	Type IV
			Type IV Wide
			Type V Square Medium
			Type V Wide (Round)

3000/4000K CCT available on request

Finish color options :

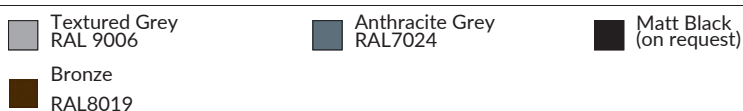

Customizable in different finishing colors

Option



Photocell

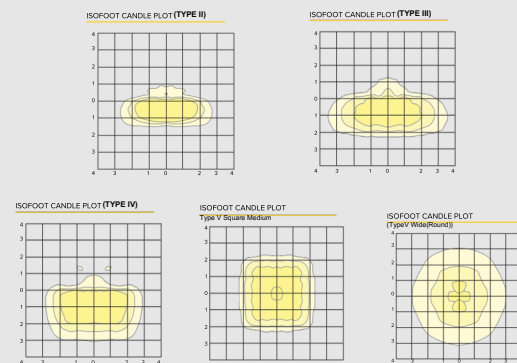

Technical features



Technical data

Wattage	200W
IP Rating	IP65
IK Rating	IK08
Material	High corrosion resistance die-cast copper-free aluminum body
Coating	Polyester powder coating with phosphochromating pre-finish
Light source	SMD high-intensity power LEDs
Standard Deviation Color Matching	:MacAdam step 3
Screws	Stainless steel
Transformer	Electronic power supply 220/240V 50/60Hz built-in or AC120-277V
Gasket	Silicone rubber
Glass	Tempered
Power cable	1 mt. neoprene power cable included
Gross weight	6.7 Kg
Surge Protection	6 KV/10KV
Notes	Can on request DALI version available on request



MR-OS-200W

Die-cast aluminium body (EN47100).
 Double layer polyester powder paint resistant to corrosion and salt spray fog.
 Silicone rubber gaskets.
 AISI 316 stainless steel external screws.
 Driver protected against voltage surges up to 10kV.
 PMMA lenses for LEDs.
 Screen made of 5mm thermal-shock resistant tempered glass.
 High quality LED sources characterized according to IES TM-30, with high color consistency <3SDCM and long useful life >60000 hours at L80.

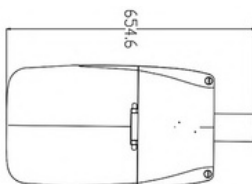
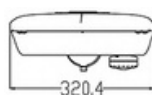

Option



Photocell

light source*	lumen output (lm)	lumin. efficacy (lm/w)	light beam options
5000°K white			Type II
			Type III
			Type IV
			Type IV Wide
			Type V Square Medium
			Type V Wide (Round)

3000/4000K CCT available on request

Finish color options :

- Textured Grey RAL 9006
- Anthracite Grey RAL7024
- Matt Black (on request)
- Bronze RAL8019

Customizable in different finishing colors

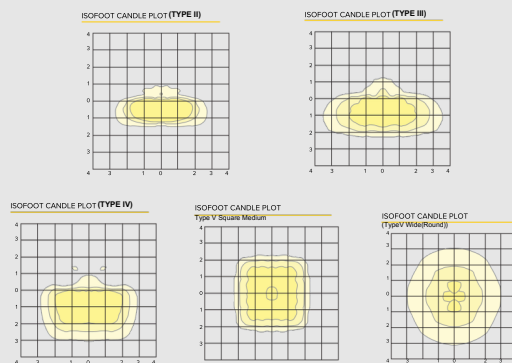



Technical data

Wattage	60W/90W/120W/150W/200W
IP Rating	IP68
IK Rating	IK08
Material	High corrosion resistance die-cast copper-free aluminum body
Coating	Polyester powder coating with phosphochromating pre-finish
Light source	SMD high-intensity power LEDs
Standard Deviation Color Matching	:MacAdam step 3
Screws	Stainless steel AISI 316
Solar Controller	Kontroler MPPT cerdas dengan manajemen baterai built-in
Solar Panel	35/6V
Battery	LiFePO4 battery 3.2V39AH
Gasket	Silicone rubber

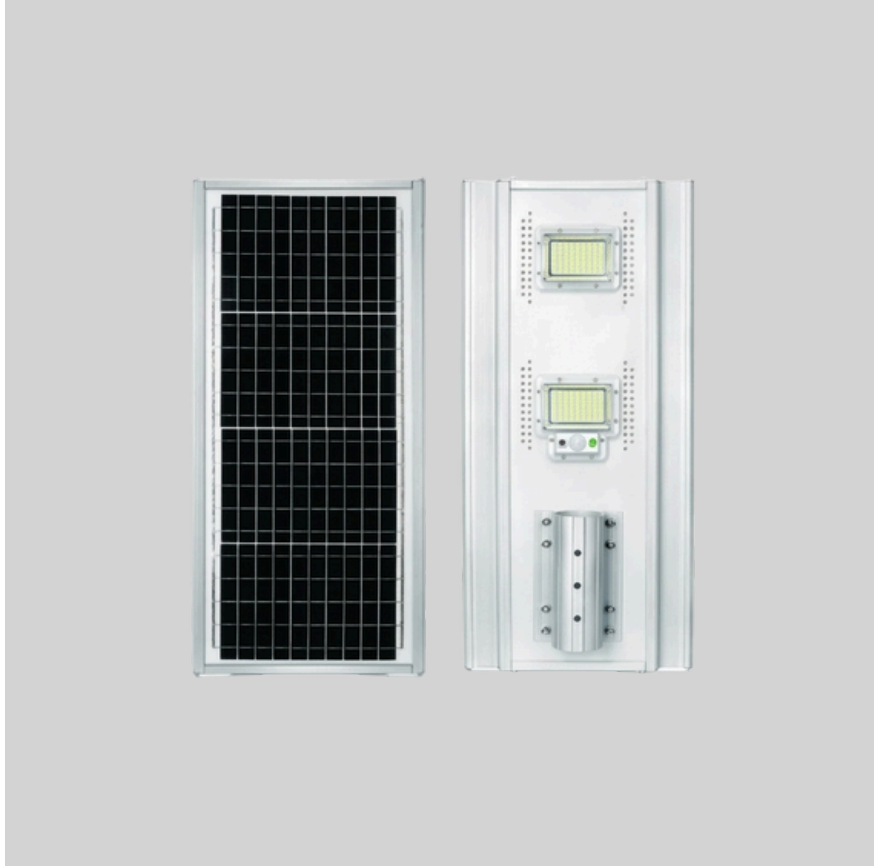

PJU Tenaga Surya SDE1001L

High-performance All-in-One (AIO) solar street lighting solution engineered for superior durability and efficiency. Constructed with a high-pressure die-cast copper-free aluminum body (EN47100), the luminaire features a double-layer polyester powder coating, providing exceptional resistance to corrosion and salt spray fog.

Equipped with high-efficacy SMD LEDs, the system delivers a stable 4000 Lumens output with a color consistency of <3SDCM. The integrated power system utilizes a high-capacity LiFePO4 battery (3.2V/39AH) and a 35W monocrystalline solar panel, ensuring reliable operation even during 3-5 consecutive rainy days.

Lumen Output (lm)	Color Temperature	Lighting Duration	Beam Type
4000 lm	6500K	Dusk-to-Dawn + 3-5 Rainy Days	Type IV Wide

3000/4000K CCT available on request

Operational Features



Smart PIR Motion Sensor

Integrated Passive Infrared (PIR) technology that detects human movement within a 12-meter range. The system automatically adjusts brightness levels (dimming) to conserve battery energy when no activity is detected, ensuring optimal performance throughout the night.

Intelligent Light Control

Advanced Photocell sensor for "Dusk-to-Dawn" automation. The luminaire automatically activates at sunset and deactivates at sunrise, providing a seamless, maintenance-free operation with 100% energy savings and zero carbon emissions.

